



OPEN JSC MACHINE-TOOL PLANT
«KRASNY BORETS»

CATALOGUE  **2020**



Machines you trust

www.krasnyborets.com

OPEN JSC MACHINE-TOOL PLANT «KRASNY BORETS»



“Collective of the plant is proud of its history and production, and first of all of its quality and reliability...”

“Krasny borets” started its history in 1900. On the territory the plant is occupying now the mechanical shops were founded, which produced stock of agriculture, kettles, barrels, repaired mill’s and distillery’s equipment.

During next years the plant has been producing jointing and mortising-milling machines, wall fasten-drilling machines, brick-make machines, peat extraction complexes.

In 1959 the plant began a new reconstruction to master the production of surface grinding machines with high and very high precision. Since this time the enterprise and its products have become famous all over the world.

The first metal-cutting machine-tool in the USSR the high precision surface grinding machine mod. 3711 produced by the plant “Krasny borets”, was adjudged with state “Quality Symbol” in 1967.

The group of workers of the plant was awarded with State Prize in the field of engineering for creation and development of complex-mechanized production of precision machines, the high level of production technology in 1971.

The plant is well-equipped for producing precision equipment of high quality which meets the requirements of the world market.

There are about 570 workers and engineering staff work at the plant, who have rich experience in production, adjustment and testing of the equipment.

The plant has been exporting its machine-tools since 1960 and now they operate in more than 110 countries of the world. Main trade partners of the plant are the organizations and firms of Russia, Germany, Turkey, Poland, Czech Republic, Spain, Syria, France, Egypt, Italy, Finland, Iran, Greece and others.

In 2000 the plant was the first of the machine-tool building enterprises of Belarus to pass successfully certification on conformity of the Quality System for producing machine tools and forging-pressing equipment with requirements of ISO-9001-96.

In 2003 and 2006 system of management of production quality was confirmed in German system of certification DAR-TGA (ISO 9001-2000) and in National system of certification STB ISO 9001-2001.

In 2009 the repeated certification of the quality management system on accordance with the requirements of STB ISO 9001-2009 in National system of confirmation and in German system of accrediting DIN-EN-ISO 9001:2008 was conducted.

In 2006 National system of certification of the Republic of Belarus certified the management of environment and production on conformity with ecological requirements in accordance with STB ISO 14001-2005.

In 2009 the validity of the environment management certificate on conformity with requirements of STB ISO 14001-2005 was prolonged.

Since 2015, JSC Machine-tool plant “Krasny Borets ” an integrated management system that combines the quality management system (QMS), environmental management system (EMS) and occupational health management system (OSS) has been operating. In 2018, the transition to the new standards STB ISO 9001-2015 and STB ISO 14001-2017 was made, after which the specialists of NP RUP “BelGISS”, Minsk, conducted the certification audit, the outcome of which was the presentation of JSC machine-tool plant “Krasny Borets” certificates of conformity in the National system of conformity and the German accreditation system (certificate № BY/112 05.01.002 00044, BY/112 06.01.002 00345, BY/112 05.04.002 01400, QMS-00065). The integrated management system covers the development, production and maintenance of metal-cutting machines and forging equipment, aimed at further ensuring high quality and competitiveness of products under safe working conditions and minimal impact on the environment.

According to the results of work in the field of quality the plant and the range of articles were awarded by prestigious awards:

- The Republic of Belarus Government Bonus for achievements in the field of quality (2000, 2003, 2006);
- The Republic of Belarus Ministry of Industry Bonus for achievements in the field of quality (2003, 2006);
- Machine mod. 3D711AF10-1, machine mod. 3D711VF11, OSH-400, Orsha-F32SH, Orsha-60120 – award “The Best goods of the Republic of Belarus in the market of the Russian Federation”;
- Machine mod. OSH-400, Orsha-F32SH, Orsha-F32U, OSH-550 3D711VF11, OSH-636 F3, TSH-2 are the prize-winners of the contest “The Best goods of the Republic of Belarus”;
- According to results of participation in specialized exhibitions the plant is awarded with diplomas.

We are pleased to report that in 2014 JSC Machine-tool plant “Krasny borets” won the prestigious award “Exporter of the Year 2014”, received a certificate from the “International Rating Union National Business Rating” for the first place in the top 3 (Gold) ranking among the exporters of the Republic of Belarus for the sum of 4 indicators of foreign economic activity:

- “The volume of exports / imports”
- “The dynamics of growth compared to previous periods”
- “Diversification, as the number of headings”
- “The number of counterparties”

We are always willing to accommodate your requests and are pleased to invite you to cooperation.



CLASSIFICATION OF PRODUCTION

◆ Horizontal - spindle compound - table surface grinding machines	4
◆ Horizontal - spindle compound - table surface - profile grinding machines with CNC	5
◆ Special vertical - spindle compound – movable table surface grinding machines with CNC	6
◆ Portal (overhead gantry) surface grinding machines with CNC	7
◆ Surface grinding machines with round table and horizontal spindle	8
◆ Grinding machines with round rotary table and vertical spindle	9
◆ Circular grinding machines, face –circular grinding machines	10
◆ Thread-grinding machines with CNC	17
◆ Machines for grinding of rings of roller spherical bearings with CNC	18
◆ Spline gear - grinding machines with CNC	20
◆ Spherical grinding machines with CNC	21
◆ Machines for creep feed grinding of hard-to-machine materials with CNC	22
◆ Machines for grinding of motor camshafts cams with CNC	24
◆ Machines for internal face-grinding with CNC	25
◆ Machines for simultaneous grinding of flat parts faces with CNC	25
◆ Machines for profiling of abrasive grinding wheels with CNC	26
◆ Machines of diamond – electrochemical grinding with CNC	26
◆ Knee-type milling machines	27
◆ Crank presses	29
◆ Bending machine	30
◆ Small-scale mechanization machines	31
◆ Cleaning system	34
◆ Technological equipment	35
◆ Machine accessories	36
◆ Industrial furniture and accessories	38
◆ Modernization and major repairs of grinding machines	39
◆ Technological capacities on machining process of parts as per customer's drawings	40
◆ For recording	

Plant renders the following services:

Major repairs and modernization of surface grinding and milling equipment: restoration of accuracy parameters and polymeric coating of guide ways; replacement of ball screw pairs; replacement of ball bearings and seals; replacement of cooling system and coolant-lubricant feed pumps; replacement of working zone guards; replacement of limit switches; replacement of low-voltage equipment; replacement of the control system onto CNC SINUMERIK 840D and electric drive onto SIMODRIVE 611; replacement of hydraulic equipment; replacement of feedback transducers onto converters HEIDENHAIN; replacement of all electric communications of machines; installation and commissioning; warranty and post-warranty service; personnel training;

- works on machining of parts according to customer's drawings.

Technological capabilities of OJSC Machine-tool plant "Krasny borets" are laser processing, gas-plasma treatment, sheet metal bending, metalware fabrication.

HORIZONTAL - SPINDLE COMPOUND - TABLE SURFACE GRINDING MACHINES

The machines have been designed for high-precision grinding of flat surfaces of various articles, and when the grinding wheel periphery profiling and installation of attachments are used – for machining of profile surfaces, slots, shoulders, and also grinding with wheel face.

Specific features of design:

- The rational design of the base, compound slide, column, table and wheelhead ensures the machine high rigidity and vibration-free operation providing stable precision and purity of machining.
- The use of ball-screw pairs in the feed units ensures smooth, high precision, backlash-free positioning.
- All working travels on machines are automatic.
- Machines are equipped with the electric components of leading world producers.
- Basic parts made from cast iron.
- Machines are produced in two different versions:
 - version 30 – with manual control without digital read-out device;
 - version 31 – with manual control with digital read-out device over 2 axes;
 - version 20 – with control from programmable logic controller.
- Production of machines with cabinet protection is possible.

OSH-450 (3D711VF11)



OSH-2030



Delivery set :

- Cooling system with lubricant –coolant feed pump and magnetic separator of coolant-lubricant refinement.
- Lubrication and table drive hydraulic station.
- Arbor for grinding wheel static balancing.
- Grinding wheel with flanges.
- Set of mounting pads.
- Quick-wearing spare parts, tools and attachments.
- Accessories for wheel dressing

The following attachments are delivered at extra price:

- Electromagnetic chuck, grinding wheel dressing mechanism, accessories for profile grinding.

3D711AF10-1 (Orsha-2045), OSH-450, OSH-550, OSH-400, OSH-400AF2, OSH-40110AF2

NAME OF PARAMETERS	MACHINE MODEL							
	OSH-2030	3D711AF10-1 (Orsha-2045) version 38	OSH-450 (3D711VF11) version 36	OSH-550 version 36	OSH-400 (Orsha-4080) version 38	OSH-400AF2	OSH-400 version 36	OSH-40110AF2
Machine accuracy class	High precision					Special high	High precision	Special high
Table surface dimensions (BxL), mm	200 x 300	200 x 450	200 x 630	320 x 630	400 x 800		400 x 1100	
Accuracy parameters achieved on workpiece:								
Workpiece dimension, mm	300x200x80	210x120x80	380x120x80	380x150x80	400x150x120		400x150x120	
Flatness, mkm	4	4	4	4	4	2,5	4	2,5
Parallelism, mkm	5	5	5	5	5	3	5	3
Roughness of surface machined by the wheel periphery, Ra	0,16	0,16	0,16	0,16	0,16	0,08	0,16	0,08
Working feeds range:								
table, m/min	Manual control	2...25	2...30	2...30	1...30		1...25	
slide, mm/stroke		0,3...20	0,3...40	0,3...40	0,3...40		0,3...40	
wheelhead, mm/stroke		0,002...0,04	0,002...0,08	0,002...0,08	0,002...0,08		0,002...0,08	
Maximum travels, mm :								
of table	310	520	670	670	810		1160	
of compound slide	220	237	245	385	445		445	
Maximum distance between table mirror and spindle axis, mm	300	460	550	650	650		650	
Dimensions of grinding wheel (DxdxH), mm	150x32x20	250x32x76	300x40x76	300x40x127	400x40...80x127		400x40...80x127	
Main drive power, kW	1,1	2,2	4,0	7,5	7,5		7,5	
Overall dimensions, mm:								
length	950	1600	2715	2715	3200		3800	
width	790	1680	1788	2105	2540	3030	2540	
height	1710	1540	2035	2140	2140	2340	2140	
Mass, kg	440/533	1800	2950	3400	3600	3656	4150	

HORIZONTAL - SPINDLE COMPOUND - TABLE SURFACE - PROFILE GRINDING MACHINES WITH CNC

Machines are designed for machining flat as well as profile surfaces, representing combinations of segments, straight lines, arcs, circles and other precisely set curves in right-angled or polar coordinate system.

Profiling of grinding wheel is realized by a special device by means of diamond roller rotation and grinding wheel head travel over coordinates Y and Z according to program from CNC system.

Specific features of machine mod. ORSHA-60120, Orsha-60150, Orsha-60200, Orsha-60240, Orsha-60300

construction:

- column and grinding wheelhead travel over linear guide ways of firm "SCHNEEBERGER".
- Slip guide ways with polymer cover.
- Table travel (coordinate X) from hydraulic cylinder or ballscrew-nut transmission.
- Automatic lubrication of longitudinal guide ways.
- CNC system SINUMERIK 828 D (840 DSL).
- Feedback by means of pulse converters FAGOR.
- Ball-screw pairs for cross and vertical travels.
- Production of machines with combined manual (hand-wheels) control and control from master controller is possible.



Schemes of processing on machines

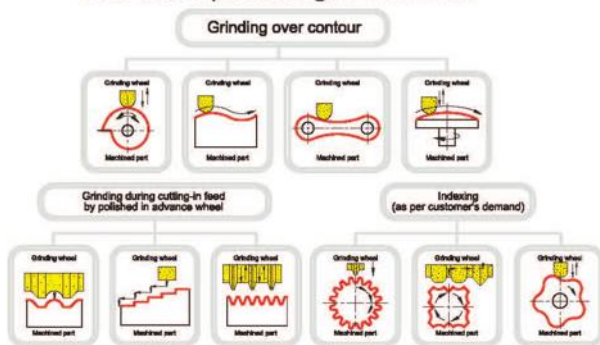

Specific features of machine mod. OSH-620.F3 construction:

- Rigid construction of bed, compound slide, column, table and grinding wheel head
- Travel of work members over coordinates Y and Z by means of high precision backlash rolling ball screw pairs.
- Linear and circular interpolation over coordinates Y and Z.
- Table travel (coordinate X) from hydraulic cylinder and ballscrew assembly.
- Automatic lubrication of guide ways.
- CNC system SINUMERIK 828D (840 DSL).
- Feedback by means of pulse converters FAGOR.

Surface-profile grinding machines can have different versions depending on number of controllable coordinates.

According to order the following extra options are possible:

- indexing device controlled from CNC with horizontal or vertical axis;
- controlled from CNC table travel by means of ball screw pair and electric motor

NAME OF PARAMETERS	MACHINE MODEL					
	OSH-620.F3	ORSHA-60120	ORSHA-60150	ORSHA-60200	ORSHA-60240	ORSHA-60300
Table mirror dimensions (B x L), mm	400 x 800	600 x 1200	600 x 1600	600 x 2000	600 x 2400	600 x 3000
Accuracy parameters achieved on workpiece:						
- Workpiece dimension, mm	500 x 150 x 120	710 x 300 x 200				
- Flatness, mkm	4	6				
- Parallelism, mkm	5	8				
- Roughness of surface machined by the wheel periphery, Ra	0,16	0,32				
Maximum working feeds						
- longitudinal table travel (axis X), m/min	2...25	2...28		2...20		
- vertical travel of grinding wheel head (axis Z), mm/stroke	0,001...0,3	0,001...0,3				
- cross travel (axis Y), mm/stroke	0,3...20	0,3...20				
Maximum dimensions of machined surfaces, mm						
- length	700	1200	1500	2000	2400	3000
- width	400	600	600	600	600	600
- height	385	440(590)	440(590)	440(590)	440(590)	440(590)
Controllable number of coordinates	3	3				
Maximum distance between table mirror and spindle axis, mm	650	640 (790)				
Grinding wheel dimensions (D x H x d), mm	400x25...63x127			400x20...100x127		
Main drive power, kW	5,5...11,0	11,0				15,0
Overall dimensions, mm:						
- length	3220	4800	5720	7400	8140	9350
- width	3100	3850	3850	3850	3850	3850
- height	2140	2400	2400	2400	2400	2400
Mass, kg	3600	8900	9100	10200	13000	15000

SPECIAL VERTICAL-SPINDLE COMPOUND-MOVABLE TABLE SURFACE GRINDING MACHINES WITH CNC

SPECIAL CNC SURFACE-GRINDING MACHINE WITH A VERTICAL SPINDLE WITH A RECTANGULAR MOVABLE TABLE AND TWO ROTARY DIVIDING TABLES MODEL OSH-665F3

The machine is designed for grinding grooves of parts of turning chucks with a diameter of 210, 250, 315, 400, 450 mm.



OSH-665F3

NAME OF PARAMETERS	VALUE
Maximum dimensions of the installed part: - diameter, mm; - height, mm;	450 200
Maximum mass of the workpiece to be installed, kg	1200
Maximum dimensions of the processed grooves, width of the groove, mm	8...60
Dimensions of the work surface of the table: - width, mm - length, mm	600 1200
Travels, mm - longitudinal position of the table (the largest by stops) - cross-section of the column, not less than - vertical to the end of the vertical spindle	1330 500 680
Grinding wheel spindle speed, min ⁻¹	4000...45000
Limits of working feeds - longitudinal travel of the table, m/min - cross-section of the column, mm/stroke - vertical travel of wheel head, mm	1-8 0,3-20 0,001...0,3
Rotation accuracy of the dividing table \varnothing 200, \varnothing 400 mm, sec	2,5
The number of T-shaped grooves in the precision indexing round tables: - diameter of the faceplate 200 - diameter of the faceplate 400	4 6
Dimensions of the grinding wheel to be installed: - outer diameter, mm - height, mm	8...63 4...32
Power of the wheel head electric spindle, kW	7,5
Overall dimensions of the machine with auxiliary equipment - length, mm - width, mm - height, mm	4560 3500 2700
Weight of the machine with auxiliary equipment, kg	9500

Specific features of design of model OSH-665F3:

- The machine has a box-shaped bed with longitudinal guides (flat and prismatic). On the back wall of the bed, a base is fixed, along the guides of which the column moves in the transverse direction.
- A wheel head with a vertical spindle (electric spindle) moves vertically along the vertical guides of the column.
- The movement of all bodies in the longitudinal, transverse and vertical direction is carried out automatically by means of screw-nut rolling gears.
- On the longitudinal guides of the bed there is a rectangular table with a rotary indexing table \varnothing 400 mm and sloped sine fixture with indexing rotary table \varnothing 200 mm mounted on its working surface. The Machine is equipped with numerical control system Sinumerik-840D CNC device of the company "Siemens" and touch sensor of the company "Renishaw".
- Maximum dimensions of the installed part: diameter-450 mm, height-200 mm.
- Electric spindle power is 7.5 kW, rotation frequency of internal grinding spindle is 5000...45 000 rpm. Accuracy of rotation of indexing table \varnothing 400 and 200 mm is 2.5 seconds.

PORTAL (OVERHEAD GANTRY) SURFACE GRINDING MACHINES WITH CNC

PORTAL SURFACE GRINDING MACHINES WITH CNC MODEL OSH-125300

The machine is designed for high-precision grinding of flat surfaces of ferrous and non-ferrous metals by pendulum and mortise grinding.

The machine has a two-post portal layout with a movable table moving in the longitudinal direction along the bed on the sliding guides from the table drive.

Surfaces grinding, the grinding wheel dressing, moving machine components is carried out by the control program in an automatic cycle or manually. The machine is equipped with CNC Sinumerik-828D Siemens.

The kinematic scheme of the machine should provide the following movements:

- rotation of the grinding wheel of the horizontal wheel head;
- longitudinal movement of the table;
- cross movement of the horizontal wheel head carriage;
- vertical movement of the horizontal wheel head;
- vertical movement of the horizontal wheel head dresser diamond;
- transverse movement of the horizontal wheel head dresser diamond;
- rotation of the vertical wheel head grinding wheel;
- transverse movement of the vertical wheel head carriage;
- vertical movement of the vertical wheel head.



Parameters name	OSH-125300
Accuracy class	High
Table mirror size, mm	1250x3000
A limit on the size of the installed workpiece, mm:	
- length	3000
- width	1250
-height	750
The maximum distance between the axis of the horizontal grinding wheel and the table surface, mm	1015
Cutting speed, m/s	35-50
Grinding wheel dimensions (D x h x d) , mm	500x100x203
Main drive power, kW	15
Grinding wheel spindle rotation frequency, rpm	1350...2300
Limits of working feeds:	
- longitudinal of table, m / min	2...20
- cross of carriage (coordinates Z and Y1), mm / stroke	0,3...20
- vertical of grinding wheel (coordinates Y and Z1), mm / stroke	0,001...0,5
- vertical of dresser diamond (coordinate V) m / min	0,001...0,2
Discreteness of movement by coordinates, mm:	
- coordinates Z; Y1	0,001
- coordinates Y;Z1	0,001
- coordinate V	0,005
Overall dimensions of the machine, mm	
- length	9500
- width	5900
- height	4200
Machine mass, kg	23000

SURFACE GRINDING MACHINES WITH ROUND TABLE AND HORIZONTAL SPINDLE

SURFACE GRINDING MACHINE WITH ROUND ROTARY TABLE AND HORIZONTAL SPINDLE MODEL OSH-644

Machine is designed for machining of flat surfaces of different articles installed and fixed on faceplate mirror of round rotary inclinable table or on magnetic chuck fixed on faceplate.

Machine is equipped with digital read-out device over three coordinates.

PARAMETERS NAME	VALUE
	OSH-644
Table diameter, mm	400
Grinding wheel dimensions (DxHxd),	300 x 40 x 76
Rotary table incline angle, degrees	±10
Main drive power, kW	4,0
Overall dimensions (length x width x height), mm	1650 x 1890 x 1800
Mass, kg	1800



Machining schemes

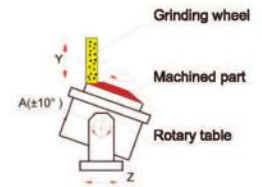

OSH-644

SURFACE GRINDING MACHINE WITH ROUND TABLE AND HORIZONTAL SPINDLE WITH CNC MODEL OSH-641



OSH-641



OSH-641*16

The rational design of the base, column, table and wheel-head made of cast iron ensures the machine high rigidity and vibration-free operation providing stable precision and purity of machining.

- CNC system Sinumeric-828D with drive SINAMATIC or NC system SIMATIK S7-1200.

- Circular travels converters – FAGOR.
- Wheel-head bearings – FAG, IBC.
- Linear guide ways – SCHNEEBERGER.
- At extra price the machine can be equipped with electromagnetic or magnetic chuck.
- The machines can be manufactured with cabinet protection.

The use of high precision backlash-free ball-screw pairs in the feed units ensures smooth, high precision, backlash-free positioning.

All working travels on machines are automatic. There is an electronic handwheel for travel over coordinates Y and Z with discreteness 1 mkm.

Machining schemes

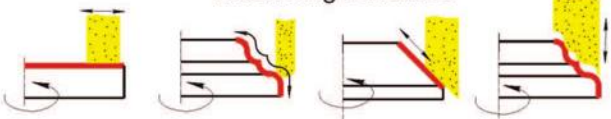

NAME OF PARAMETERS	VALUE		
	OSH-641*16	OSH-641*18	OSH-641
Table diameter, mm	600	800	1200
Maximum dimensions of machined work piece, mm:			
- diameter	600	800	1200
- height (with installation on the table mirror):	230	250	450
Rotary table incline angle, degrees	±5	±5	–
Grinding wheel dimensions (DxHxd), mm	400 x 50 x 127	400 x 80 x 127	400 x 20...100 x 127
Ranges of work members trave/speeds:			
- of table faceplate rotation, min-1 (coordinate B)	1...95	1...60	2...30
- of cross travel of column, mm/min (coordinate Z)	10...400	10...500	10...630
- of vertical travel of wheel-head, mm/min (coordinate Y)	0,001...0,03	0,001...0,03	0,001...0,3
Main drive power, kW	7,5	11,0	11,0
Spindle rotation frequency, min-1	1450	1450	1450
Overall dimensions of machine , mm : length x width x height	2900 x 2540 x 2140	3750 x 2800 x 2190	3750 x 3500 x 2250
Mass, kg	4000	6000	9000

GRINDING MACHINES WITH ROUND ROTARY TABLE AND VERTICAL SPINDLE

SURFACE GRINDING MACHINES WITH ROUND INCLINABLE ROTARY TABLE AND VERTICAL SPINDLE WITH CNC MODEL OSH-623, OSH-642



OSH-642



OSH-642*16

Grinding machines are designed for high precision grinding of outward and inward cylindrical surfaces and also faces in multi – step parts - a kind of body of revolution.

Sphere of use of semiautomatic machine is enterprises with large-scale and mass production.

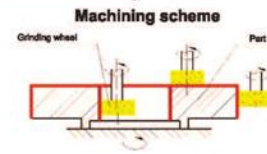

NAME OF PARAMETERS	VALUE			
	OSH-623	OSH-642*16	OSH-642*18	OSH-642
Table mirror diameter, mm	400/600	600	800	1200
Maximum dimensions of the machined work piece, mm				
-outward maximum diameter	400/600	600	800	1200
-inward minimum diameter	20	90	90	100
-maximum height	110/200	250	250	150
Rotary table incline angle, degrees	-/±5	±5	±5	-
Dimensions of grinding wheel installed on semiautomatic machine, mm				
- outward diameter	25...80	80...125	80...125	80...125
- inward diameter	10...32	20...32	20...32	20
Spindle rotation frequencies ranges, min-1	6000...30 000	2000...16000	2000...16000	5000...30000
Article table rotation frequencies ranges, min -1	5...250/1...95	1...95	1...95	2...30
Discreteness over controllable coordinates Y / Z, mkm	0,001	0,001	0,001	0,001
Speed of quick adjustment travels, mm/ min				
- of wheel- head	1600	1600	1600	3200
- of column	4000	4000	4000	4000
Main drive power, kW	22,0 (electric spindle)	4,1 (fortuna)	5,5 (fortuna)	22,0 (electric spindle)
Overall dimensions : length x width x height, mm	2800x2300x2140	2800 x 3000 x 2650	2950 x 3200 x 2650	4800 x 3500 x 2250
Mass, kg	4400	4300	5300	8700

SEMIAUTOMATIC ROTARY GRINDER WITH VERTICAL SPINDLE WITH CNC MODEL OSH-642 VERSION 11

Semiautomatic rotary grinder with vertical spindle with CNC mod. OSH-642 version 11 is designed for grinding the outer diameter of parts type "chisel" from tungsten alloys. The scope of the machine is small-scale and mass production.



OSH-642
VERSION 11

PARAMETERS NAME	VALUE
Table mirror diameter, mm	500
Maximum dimensions of the workpiece:	
- height, mm	700
- outer diameter, mm	500
- the maximum weight of the workpiece, kg	750
Dimensions of the outer grinding wheel, mm	
- outer diameter	500
- rim diameter	203,2
- height	30
Dimensions of the inner grinding wheel, mm	
- outer diameter	50...125
- rim diameter	20/32
- height	10...30
Grinding wheel spindle drive for external grinding:	
- power, kW	40
- the spindle rotation frequency	700...1900
Grinding wheel spindle drive for internal grinding:	
- power, kW	2,2
- the spindle rotation frequency	3000...12000
Discreteness by controlled coordinates X/ Z, μm	1,0
Overall dimensions: length x width x height, mm	4200 x 3000 x 4000
Mass, kg	8300

SEMI-AUTOMATIC SPECIAL SURFACE GRINDING MACHINE WITH CNC MOD. OSH-652F3

The semiautomatic special grinding machine is designed for grinding external and internal surfaces and flat parts such as bodies of rotation.

The machine has a portal arrangement, with a rotary round table and traveling wheelhead in longitudinal and vertical direction. Wheelhead has a capacity of turn in vertical plane from controllable drive. Reversible rotation of table is foreseen. Grinding wheel dressing is realized by dressing mechanism diamond roll, due to the movement of the grinding wheel in two coordinates.



OSH-652F3

NAME OF PARAMETERS	VALUE
Diameter of working surface of round table, mm	1700/2000
Parameters of machined articles: - maximum height, mm - maximum diameter, mm - mass, kg	600 1700/2000 1500
Dimensions of grinding wheel (D x H x d), mm	350 x 127 x 100
Turning angle of grinding spindle axis in vertical plane, degrees	±5 (±30)
Grinding wheel rotation frequency, min ⁻¹	2000
Table faceplate rotation frequency, min ⁻¹	2,0...30
Discreteness of cross, vertical travels, mm	0,001
Discreteness of wheel-head turn, degree	0,001
Main drive power, kW	15
Overall dimensions: length x width x height, mm	3700 x 2300 x 2250
Mass, kg	12000

CIRCULAR GRINDING MACHINES, FACE-CIRCULAR GRINDING MACHINES

SEMI-AUTOMATIC SPECIAL CIRCULAR GRINDING MACHINE WITH CNC MOD. OSH-618F3

Semiautomatic machine is designed for high precision grinding of outward cylindrical surfaces and grooves in multi – step parts - a kind of bodies of revolution and also outward parts of cam type.

Sphere of use of semiautomatic machine is enterprises with large-scale and mass production.

The specific feature of semiautomatic machine is use of grinding (of el'bor borazon material) wheel dynamic balancing device, use of lubricant-coolant on oil base and universal feed system, gathering, lubricant-coolant clearing, grinding wheel and machined workpiece rotation frequency regulation, CNC system use, use of rapid grinding.

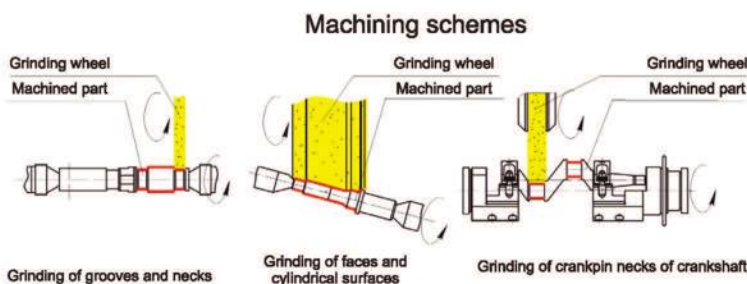

Grinding of grooves and necks

Grinding of faces and cylindrical surfaces

Grinding of crankpin necks of crankshaft



OSH-618F3

NAME OF PARAMETERS	VALUE
Maximum dimensions of installed workpiece: diameter x length, mm	300 x 250
Maximum travels, mm of compound slide / of wheel head	280/170
Dimensions of grinding wheel: D x H x d, mm	450 x 8...63 x 127
Main drive power, kW	3,0 (5,5)
Spindle rotation frequency ranges, min ⁻¹	1500...4000
Overall dimensions with attached equipment: length x width x height, mm	3840 x 2130 x 2140
Mass, kg	4500

CIRCULAR GRINDING SEMIAUTOMATIC MACHINE WITH CNC MODEL OSH-660F3

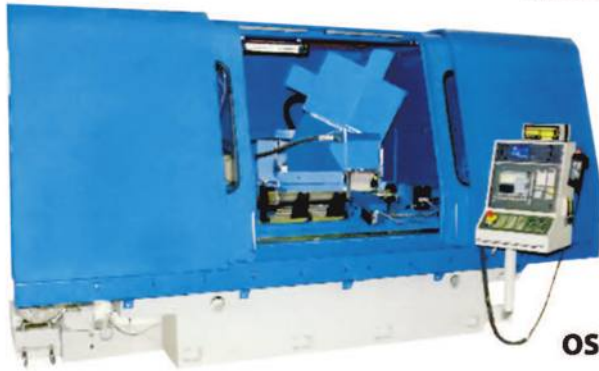

OSH-660F3

The machines are designed for outward grinding of circular surfaces and adjoining to them faces by abrasive or el'bor borazon material wheels. Cutting-in of the grinding wheel is realized perpendicularly to the work piece axis on the semiautomatic machine model OSH-660F3.

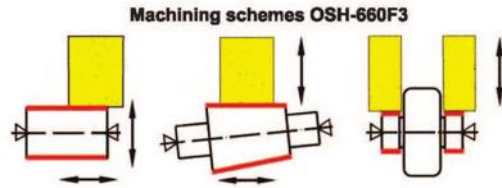

NAME OF PARAMETERS	VALUE			
	OSH-660F3			
	*00	*17(20)	*15	*30
Machining length, mm	1000	2000	2400	3000
Centres height, mm	180	285	285	285
Grinding wheel dimensions (D x H x d), mm	750x80...150x305			
Main drive power, kW	20,0	20,0(30,0)	18,5	18,5
Linear and circular coordinates controllable by CNC	X, Z, V, W	X, Z	X, Z	X, Z
Discreteness of coordinates X/Z/V/W mkm	0,001			
Overall dimensions: - length x width x height, mm	4300 x 4170 x 2370	7230x4200x 2480	8240x4200x 2150	7900 x 4200 x 2480
Mass, kg	10500	14000	15000	16000

SEMIAUTOMATIC END FACE - CYLINDRICAL GRINDING MACHINE WITH CNC MODEL OSH-650F3

Semi-automatic end-face cylindrical grinding machine with CNC model OSH-650F3 (hereinafter referred to as the machine) is designed for external grinding of cylindrical, conical and end surfaces of shaft-type parts made of cast iron, steel and their alloys.

The scope of application of the machine is enterprises of serial and large-scale production.

The machine can be equipped with a CNC system from "Siemens", "Mitsubishi", or "Fanuc" and incremental sensors (linear displacement converters) for two programmable coordinates (cross movement of the wheel head – X coordinate, longitudinal movement of the table – Z coordinate).

NAME OF PARAMETERS	OSH-650F3
Maximum dimensions of the workpiece to be installed: - length, mm - outer diameter, max / min, mm	1000 300/20
Maximum weight of the part to be installed, no more than, kg	100
Grinding wheel dimensions: - outer diameter, mm - inner diameter, mm - height, mm	750 305 100
Minimum diameter of the worn grinding wheel, mm	550
Main drive power, kW	20
Rotation speed of wheel head spindle, rpm	1270...2400
Rotation speed of the workpiece, rpm	100...500
Cutting speed, m/s	50
Speed of installation movements: - table, m/min - wheel head, m/min	4 4
The greatest move: - cross at an angle, mm - longitudinal, mm	400 1380
Discreteness of moving by controlled coordinates: Z-longitudinal movement of the table, mkm X-cross movement of the wheel head, mkm	1 1
Overall dimensions of the machine with auxiliary equipment: - length (from left to right), mm - width (front-back), mm - height, mm	4800 4450 2400
Weight of the machine with auxiliary equipment, kg	10500
Precision processing parameters: - radial runout, no more than, mkm - end runout, no more than, mkm - roughness, Ra, mkm	2 3 0,32



OSH-650F3

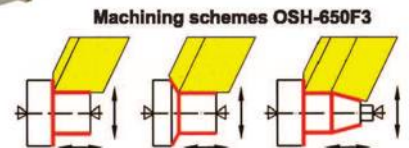

The layout of the machine.

The machine has an arrangement with a moving table in the longitudinal direction on which the workpiece is installed and moving the wheel head at an angle to the axis of the centers of the workpiece. The headstock with electric drive and the tailstock are mounted on the upper working surface of the movable table. The tailstock center tightening and releasing is realized hydraulically with foot pedal control or from the machine control panel.

Movement of all working bodies is carried out by means of ball-screw pairs. The axis of the wheel wheel is deployed on the wheel head at an angle of 26° relative to the axis of the part. The wheel head is equipped with a mechanism for the orientation of the workpiece (determining the position of the end of the part at Z coordinate).

Grinding of parts is performed by rotating the workpiece and the grinding wheel, as well as moving the wheel head at an angle to the center axis with longitudinal oscillation of the workpiece, if necessary.

On the headstock there are two dresser diamonds for dressing the grinding wheel profile. Surface treatment and the grinding wheel dressing is performed automatically.

The grinding working area is protected by box-shaped protection with an open or closed top.

SEMI-AUTOMATIC CIRCULAR GRINDING MACHINE WITH CNC MODEL OSH-651.2.F3



OSH-651.2.F3



Semiautomatic circular grinding machine with CNC model OSH-651.2.F3 (hereinafter referred to as the machine) is designed for external grinding of cylindrical necks and pre-step parts and ends of pre-step parts of carriage axles as part of an automatic line.

The scope of application of the machine is enterprises of serial and large-scale production.

NAME OF PARAMETERS	OSH-651.2.F3
Maximum dimensions of the workpiece to be installed, mm: - outer diameter - length	210 2250
Maximum mass of the workpiece to be installed, kg	500
Grinding wheel according to GOST 2424- - outer diameter, mm the maximum (new) the minimum (worn) - internal diameter, mm - height for grinding the neck and pre-step part, mm	750 480 305 258
Travels, mm: - cross travel of the wheel head - longitudinal travel of the table	420 400
Feed rate, mm: - cross feeds of wheel head - longitudinal feeds of the table	0,001 0,001
Rotation speed, min -1: - grinding wheel spindle - work head spindle	1280...2130 stepless regulation 20...300 stepless regulation
Cutting speed, m/s	30...50
Limits of working feeds, mm/min.: - cross feeds of wheel head - longitudinal feeds of the table	0,1...2000 10...4000
Speed of installation movements, m / min. - cross travels of wheel head - longitudinal travel of the table	5 8
Main drive power, kW	30
Overall dimensions of the machine without a manipulator, mm - length (from left to right) - width (front-back) - height	5800 3850 2480
Weight of the machine with additional equipment, kg without auxiliary equipment, kg	15000 13000

Installing the machine in an automatic line.

The total number of machines of the OSH model is 651.2.F3 used in the automatic line – two units. The machines are installed in series, facing each other. To ensure the removal and installation of the workpiece, each machine is equipped with a portal manipulator with hydraulic and electrical equipment.

The machine has an arrangement with a movable table moving in the longitudinal direction and a wheel head moving in the transverse direction.

On the upper table are installed: the headstock, the tailstock, pusher, the mechanism for the grinding wheel dressing with a diamond roller, and the inprocess gage mechanism.

The machine is equipped with a CNC system, an inprocess gage, a device for the grinding wheel dynamic balancing, and a mechanism for orienting the workpiece. The axis of the wheel head spindle is turned to the right at an angle $\alpha=12^\circ$. The work head with an electric drive and the tailstock are mounted on the upper working surface of the movable table. Movement of all working bodies is carried out by means of ball-screw gears.

The workpiece is based in the centers of the headstock and tailstock, the axial orientation of the part is performed using a touch sensor on the table.

Grinding of the part is performed by rotating the workpiece and moving the wheel head perpendicular to the center axis.

Surface treatment and grinding wheel dressing are performed automatically according to the control program. The machine automatically compensates for the amount of removal of the grinding wheel profile when dressing. The grinding wheel dressing mechanism is installed on the machine table.

SEMI-AUTOMATIC MULTI-PURPOSE CIRCULAR GRINDING MACHINE WITH CNC AND NC MOD. OSH-525F3

The semiautomatic machine is designed for outward and inward grinding of cylindrical, conic and shaped surfaces of parts fastened in chuck and centres. The semiautomatic machine has the arrangement with traveling in longitudinal direction table on which the machined part is installed and with travel of wheel-head perpendicular to the axis of the machined part centres.



OSH-525F3

Machining scheme OSH-525 F3 vers. 01

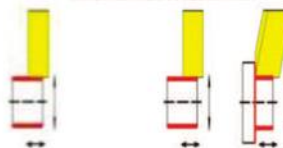

Machining scheme OSH-525 F3 vers. 04

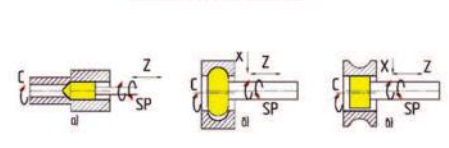

NAME OF PARAMETERS	VALUE	
	OSH-525 F3	OSH-525 F3 vers. 01
Maximum dimensions of installed work piece - in centres: diameter / length, mm - in chuck: diameter / length, mm	220/500 200/250	220/720 200/250
Dimensions of grinding wheel, max - for outward grinding: (D x H x d), mm - for inward grinding: (D x h), mm	500x50x203 32 x 20	500x50x230 -
Maximum turning angle, degrees: - of upper table clockwise / anticlockwise - of workhead when machining in chuck clockwise / anticlockwise - of wheel-head clockwise	6/6 30/90 180	6/6 30/90 180
Rotation frequency, rpm	60 000	-
Main motion drive power, kW Electric spindle for inward machining power, kW	5,5 3,2	5,5 -
Overall dimensions: length x width x height, mm	3800x3850x1900	
Mass, kg	4820	4320

UNIVERSAL CIRCULAR GRINDING MACHINES WITH MASTER CONTROLLER MODEL OSH-510F2, OSH-518F2



**OSH-510F2
OSH-518F2**

Machine has the arrangement with traveling table on which the machined part is installed and with traveling of wheelhead perpendicularly to machined part centres axis. Work head with electric drive and tailstock are fastened on working surface of upper table. Internal grinding operations are realized with folding grinding spindle. Grinding wheels dressing is produced by mounted diamond installed on table. The machine is equipped with program control SIMATIK S7-1200.

The semiautomatic machine is designed for outward and inward grinding of cylindrical, conic and face surfaces in chuck and centres.

Machining scheme for OSH-510F2 as well as for OSH-660.1.F2

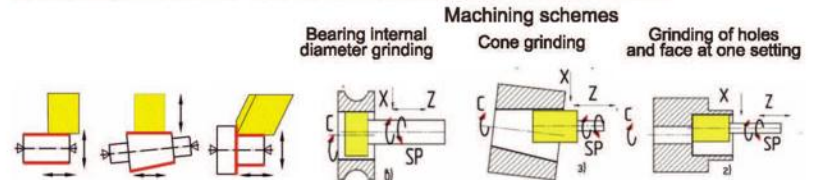

NAME OF PARAMETERS	VALUE		
	OSH-510F2	OSH-518F2	OSH-518F2 vers07
Maximum dimensions of installed work piece: - in centres: diameter / length, mm - in chuck: diameter / length, mm	100/250 70/150	150/400 100/150	200/580 125/150
Dimensions of grinding, max - in centres: diameter / length, mm - in chuck for outward grinding: diameter / length, mm - in chuck for inward grinding: diameter / length, mm	100/225 70/160 4...40/50	150/400 100/150 4...40/50	200/560 125/150 -
The angle of rotation, max, deg: - Upper table clockwise / counter-clockwise; - Workhead during processing in chuck clockwise / counter-clockwise; - Wheelhead ;	+/- 3 - 30/+ 90 ±20	+/- 3 - 30/+ 90 ±20	+10/- 3 - 30/+ 90 + 15/- 15
Main drive power, kW	2,2	2,2	3,0
Spindle power for internal processing, кВт	1,1	1,1	-
Rotational speed of internal grinding spindle, rpm	4000...24 000		-
Mass with attached equipment, kg	2000	2200	3000
Overall dimensions: length x width x height, mm	1750x2140x1520	1800x2140x1520	3000x2400x1750
Grinding wheel dimensions (DxHxd), mm	250x76x25		3000x76x10...40

UNIVERSAL CIRCULAR GRINDING MACHINE WITH CNC MODEL OSH-518F3

NAME OF PARAMETERS	OSH-518F3
Maximum dimensions of the workpiece to be installed: - in centers: diameter / length, mm - in chuck: diameter / length, mm	180 / 320 160 / 300
Grinding dimensions, max: - in centers: diameter / length, mm - in the chuck for external grinding: diameter / length, mm - in the chuck for internal grinding: diameter / length, mm	8...180 / 300 160 / 280 18...150 / 100
Workpiece weight, max - in the centers / in the chuck, kg	30 / 15
Centers height, mm	120
Main drive power, kW	2,2
The internal grinding spindle power, kW	6
Internal grinding spindle rotation frequency, rpm	6000...40000
Rotation speed of the workpiece, rpm	0,1...100
Angle of rotation: - wheel head, degree - upper table, degree - work head, degree	+10...-180 +3...-3 +15
Overall dimensions of the machine: - length; mm - width; mm - height, mm	2200 2900 1820
Weight of the machine with auxiliary equipment, kg	3100



The machine is designed for grinding external and internal cylindrical and conical surfaces, as well as profile grinding of internal and external surfaces. The machine has a layout with a moving table on which the workpiece is mounted and the movement of the wheel head perpendicular to the center axis relative to the workpiece.

The machine is equipped with a CNC system and has three programmable coordinates: longitudinal movement of the table (Z), transverse movement of the wheel head (X), rotation of the work head spindle (C). The machine can be manufactured with cabinet type protection and without.

movement of the table (Z), transverse movement of the wheel head (X), rotation of the work head spindle (C). The machine can be manufactured with cabinet type protection and without.

UNIVERSAL CIRCULAR GRINDING MACHINES WITH MASTER CONTROLLER

Designed for external grinding by abrasive CBN of outer diameters and adjacent ends and also for grinding of internal holes and adjacent ends by internal grinding spindle. The machine is equipped with program control SIMATIK S7-1200.



OSH-530F2



ОШ-660.1.Ф2

NAME OF PARAMETERS	VALUE	
	OSH-660.1.F2	OSH-530F2
Grinding length / grinding diameter , mm	1100/240	1000/400
Grinding wheel DxdxH, mm	500x203x50	500x203x40...80
Grinding wheel drive power, kW	5,5	5,5
Spindle for internal machining power, kW	1,5	4
Controllable from master controller linear coordinates	X,Z	
Rotation frequency, rpm	4000...12000	
Overall dimensions of machine, mm:		
- length	4370	4300
- width	3400	3200
- height	1900	1900
Machine mass with attached equipment, kg	7000	7000

UNIVERSAL CIRCULAR GRINDING MACHINES WITH MASTER CONTROLLER

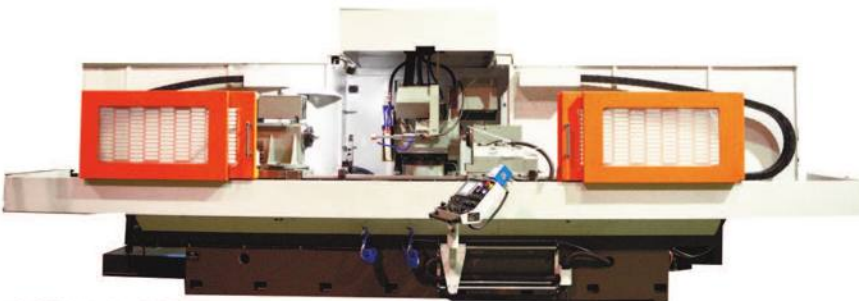

OSH-661 AF2

Machining schemes

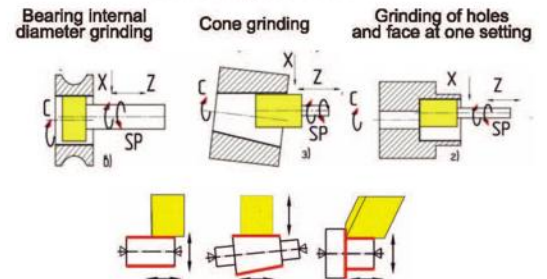

NAME OF PARAMETERS	VALUE
	OSH-661AF2
Grinding length / grinding diameter , mm	2000/400
Grinding wheel DxdxH, mm	500x203x50
Grinding wheel drive power, kW	4
Spindle for internal machining power, kW	4
Controllable from master controller linear coordinates	X,Z
Rotation frequency, rpm	1200...2800
Overall dimensions of machine, mm:	
- length	6900
- width	4200
- height	2480
Machine mass with attached equipment, kg	13000

UNIVERSAL CIRCULAR GRINDING MACHINE OF HIGH PRECISION WITH CNC WITH A ROTARY WHEEL HEAD AND A MOVABLE RECTANGULAR TABLE MODEL OSH-660.3.AF3.

The machine is designed for external and internal grinding of cylindrical and conical surfaces with end faces of rotation bodies made of tool steels with stepped and curved profiles.

Specific features of machine mod. OSH-660.3.AF3 construction:

- The wheel head has three spindles: two spindles for external grinding and end grinding, and one for internal grinding. For internal grinding operations, a high-speed electric spindle at 63,000 rpm is used.
- Rotation of the wheel head in the horizontal plane and longitudinal movement of the table is carried out by linear actuators.
- Processing parameters: grinding length - up to 1000 mm, maximum external diameter-340 mm, internal grinding processing length-200 mm, maximum diameter – 250 mm.
- Processing of parts on the machine is carried out in automatic mode with control from the SINUMERIK-828D CNC system of Siemens.

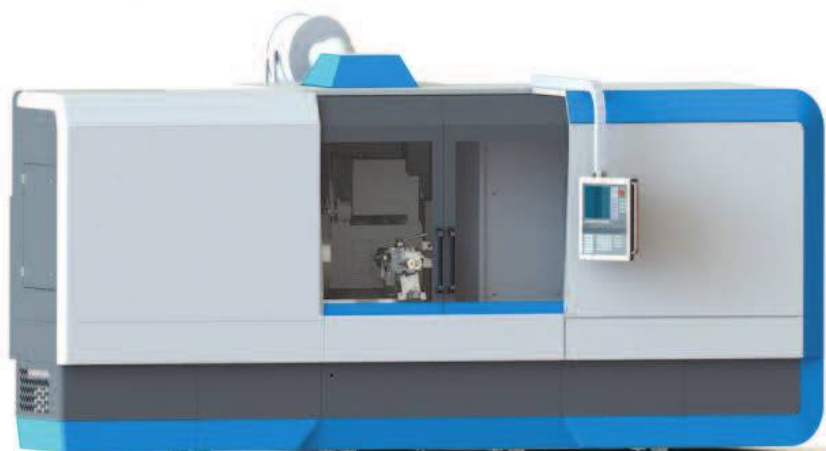

OSH-660.3.AF3

- The machine is equipped with an active control device to ensure accurate measurement of the workpiece diameter to be processed.

NAME OF PARAMETERS	MACHINE MODEL
	OSH-660.3.AF3
Maximum dimensions of the workpiece to be installed: - length, min/max; mm - outer diameter, min/max; mm	30/1000 4/350
Surface dimensions: external grinding - length; mm - diameter; mm Internal grinding - length; mm - diameter; mm	50...950 4...340 10...200 8...250
The size of the installed grinding wheels (external grinding), grinding the face/outer grinding: - outer diameter; mm - inner diameter; mm - height; mm	500 / 400 203 / 127 63 / 63
Main drive power, kW	7,5
Rotation speed of the wheel head round-grinding spindle, rpm	1400...4000
Processed part rotation frequency, rpm	30...1000
Speed of adjustment movements: - cross of wheel head; m/min - longitudinal travel of the table; m/min	10 10
Maximum travels: - cross; mm - longitudinal, mm	420 1150
Rotation speed of the internal grinding spindle, rpm	10000...63000
Angle of rotation of the wheel head, degree	-90...+180
Angle of rotation of the work head	-30...+90
Centers of work head and tallstock	KM4
Discreteness of moving along the X and Z coordinates (resolution), mkm	0,1
Range of external diameters controlled by the active control device, mm	6...200
Overall dimensions of the machine with auxiliary equipment: - length - width - height	4000 3700 2000

SEMIAUTOMATIC SPECIAL CIRCULAR GRINDING MACHINE WITH CNC MOD. OSH-655F3

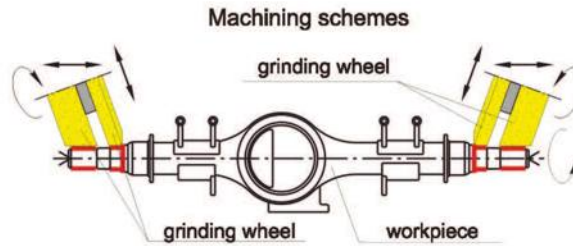

Semiautomatic machine is designed for finish grinding of external cylindrical surfaces and ends of parts: housing of middle and rear axle of KAMAZ.

NAME OF PARAMETERS	VALUE
Maximum dimensions of installed workpiece ,mm: - length - diameter	2400 500
Machine spindle indicators: - Diameter of the external cone of the spindle of the grinding wheel, mm - The size of the inner cone in the headstock spindle - The size of the inner cone in the tailstock spindle	125 Morse cone 6 Morse cone 6
Main drives, kW	22
Accuracy parameters of machined parts: - Radial runout tolerance of machined surfaces relative to the centers, mm - Face runout tolerance of machined surfaces relative to the centers, mm - Roughness of machined surfaces, Ra	0,01 0,01 0,63...1,25
Overall dimensions: length x width x height, mm	4800x4450x3300
Mass with attached equipment, kg	20000

SEMIAUTOMATIC CYLINDRICAL GRINDING CNC OSH-660F3*28

Semi-automatic cylindrical grinding machine with CNC mod. OSH-660F3 version 28 is designed for external grinding of smooth cylindrical and conical surfaces of the rotation body type.

The following equipment is applied on the machine:

- CNC system Sinumerik 828D Siemens with the Sinamics servo drives;
- Linear feedback sensor over the X-coordinate;
- Electric cabinet equipped with a refrigeration unit;
- Closed roller linear guides over X-coordinate;
- High-precision, backlash-free ball screw transmissions in feed drives mechanisms;
- High precision angular contact ball bearings for wheel head spindle, headstock spindle;
- Device for dynamic balancing of the grinding wheel for external grinding with GAP function;
- Inprocess gage of external grinding;
- Guarding of the working area of the open type.



NAME OF PARAMETERS	VALUE
Accuracy class of the machine according to GOST 8-82	Π
Maximum dimensions of the installed workpiece, mm: - length when processing the outer diameter - outer diameter	2800 50...560
Maximum dimensions to be processed, mm: - outer diameter - length	50...560 2700
Dimensions of the installed grinding wheel for external grinding, mm: - outer diameter - inner diameter - height	750 305 100
Main drive power, kW:	18,5
Main drive spindle rotation frequency, rpm:	1100...2800
Workpiece rotation frequency, rpm:	20...280
The speed of longitudinal adjustment travel, m/min: - longitudinal - cross	6 6
Discreteness of travels along controlled coordinates, μm:	1
Maximum displacement, mm: - table (Z coordinate); - wheel head (X coordinate).	2900 400
Overall dimensions of the machine with additional equipment: length x width x height, mm:	5500 x 4200 x 2480
The mass of the machine with attached equipment, kg:	22 000

HIGH SPEED INTERNAL PROFILE GRINDING SEMI-AUTOMATIC MACHINE WITH CNC MODEL OSH-636F3, INTERNAL GRINDING SEMIAUTOMATIC MACHINE WITH CNC MODEL OSH-686F3

Semiautomatic machine model OSH-636F3 is designed for profile grinding of holes, grinding of cone holes is possible. Sphere of semiautomatic machine use is enterprises with large - series and mass production.

Semiautomatic machine model OSH-686F3 is designed for grinding of holes and grinding of adjoining faces. Sphere of use is enterprises with small - series and serial production.



OSH-686F3

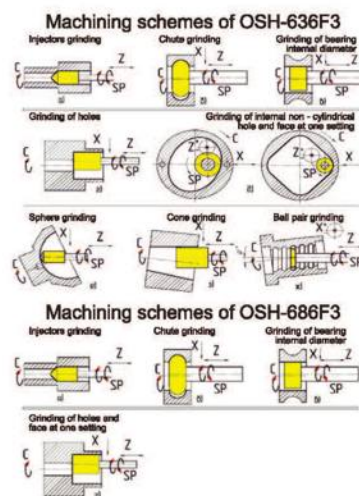

NAME OF PARAMETERS	VALUE		
	OSH-636F3	OSH-686F3	OSH-686.5F3
Maximum dimensions of machined surfaces, mm			
- length	150		650
- internal diameter	200	200	600
- external diameter	180	180	600
Grinding wheel dimensions installed on semiautomatic machine, mm			
- external diameter	10...63	10...63	50...125
- internal diameter	6...20		15...32
Electric spindle rotation frequencies limits, min ⁻¹ (max)	24000/45000	75000...105000	Equipped with removable electric spindles*
Work head spindle rotation frequency, min ⁻¹	20...800	20...800	10...500*
Overall dimensions, mm			
- length	3500		4400*
- width	3700		2500*
- height	2000		1820*
Mass, kg	4000		8500*
Axis C	+		
Axis B		+	

THREAD-GRINDING MACHINES WITH CNC

SEMI-AUTOMATIC THREAD-GRINDING MACHINE WITH CNC MODEL OSH-633F3

The semiautomatic machine is designed for outward grinding cylindrical and conic left and right, single- and multistart threads of different profile.

The semiautomatic machine has the arrangement with traveling wheel-head in longitudinal and cross directions relative to stationary rotating part. Wheel-head has the opportunity of turning to the left and right sides relative to the axis of machined part in vertical plane on the lifting angle of helical groove.

Machining scheme

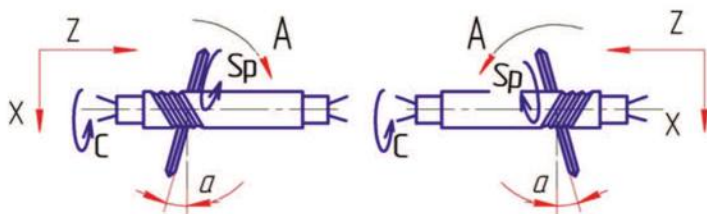

OSH-633F3

NAME OF PARAMETERS	OSH-633F3*06	OSH-633F3*04
Maximum dimensions of installed work piece: diameter x length, mm	150 x 530	250 x 1450
Diameter of ground thread, mm	3...150	3...200
Maximum angle of ascent of ground thread helical curve, degrees	±60	±30
Main drive power, kW	7	7,5
Spindle rotation frequency, rpm	2150...4550	2100...4500
Overall dimensions: length x width x height, mm	3700 x 3200 x 2000	4300 x 3560 x 2600
Machined part rotation frequency, rpm	0,1...120	0,1...150
Mass, kg	7500	8000

INTERNAL THREAD-GRINDING MACHINE WITH CNC MOD. OSH-635.1.F3

Machine is designed for grinding of internal thread of nuts and ball-screw pair beckets and has the traveling in cross direction slides (coordinate X) and in longitudinal direction table with work head (coordinate Z), wheel-head is rotary, travels vertically (coordinate Y). The machine is equipped with CNC system, electric spindle, touch sensor for detection of part location on machine, diamond roller for grinding wheel profile dressing.



OSH-635.1.F3

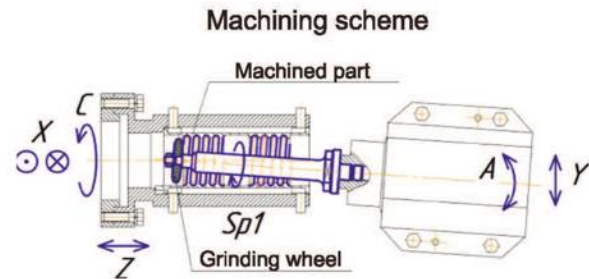

NAME OF PARAMETERS	VALUE
Maximum dimensions of installed workpiece in chuck: outward diameter x length, mm	330 x 300
Parameters of machining: - inside maximum diameter - inside minimum diameter - grinding length	255 25 300
Dimensions of grinding wheel $D_{max} \times H$	22...100x20
Number of controllable coordinates	5
Wheel-head turning angle (rotary angle), degrees	-15; +15
Grinding wheel rotation frequency, rpm	6000...45000
Machined part rotation frequency, rpm	1...100
Overall dimensions: length x width x height, mm	3500 x 4100 x 2550
Mass, kg	9000

MACHINES FOR GRINDING OF RINGS OF ROLLER SPHERICAL BEARINGS WITH CNC

MACHINE FOR GRINDING THE FACES OF MIDDLE SUPPORTING SKIRTING OR EXTREME SKIRTINGS OF ROLLER-SPHERICAL BEARINGS INWARD RING WITH CNC MODEL OSHP-8



OSHP-8

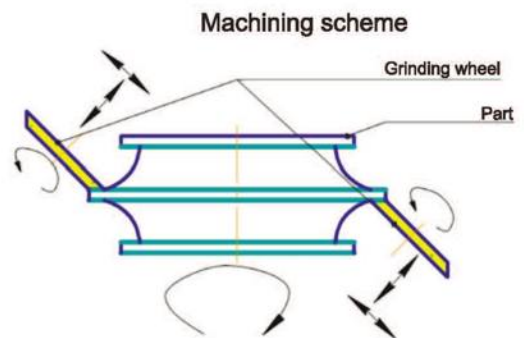

NAME OF PARAMETERS	VALUE
Maximum dimensions of installed work piece, mm: - outward diameter of middle skirting - outward diameter of extreme skirting - rings width	350...570 360...540 150...245
Grinding wheel dimensions (DxHxd), mm	400x127x10
Grinding wheel drive power, kW	5,5
Number of controlled coordinates	8
Discreteness over coordinates, mm	0,001
Overall dimensions: length x width x height, mm	3950 x 3900 x 1970
Mass, kg	8500

MACHINE FOR GRINDING THE ROLLER – SPHERICAL BEARINGS INWARD RING ROLLING TRACKS WITH CNC MOD. OSHP-226

Machine is designed for simultaneous grinding both roller-spherical bearings inward ring rolling tracks by two grinding wheels. The machined part is installed in a special electromagnetic chuck with support on two shoes. Profiling of grinding wheels is realized by rotating diamond roller.

Machining scheme

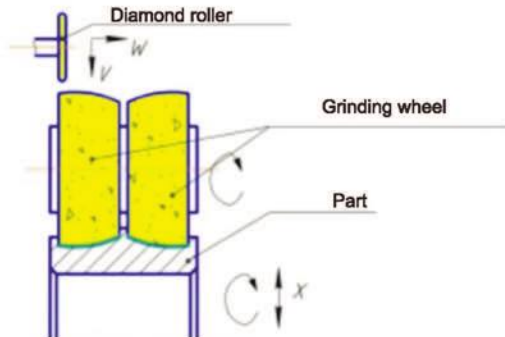

OSHP-226

NAME OF PARAMETERS	VALUE
Maximum dimensions of installed work piece, mm: - rolling track radius - outward diameter of middle skirting - rings width	200...370 350...570 130...245
Machining parameters, mm: - rolling tracks diameter - stock removal	320...520 1,25...2,3
Main drive power, kW	30
Controlled by CNC linear coordinates	X, W, V
Discreteness of coordinates X, W, V, mm	0,001
Overall dimensions: length x width x height, mm	3500 x 3500 x 2200
Mass, kg	7000

MACHINE FOR GRINDING THE ROLLER – SPHERICAL BEARINGS OUTWARD RING ROLLING TRACK SPHERE MOD. OSHP-259

The machine is designed for grinding of surfaces of rolling tracks of outward rings of roller radial spherical bearings by the method of crisscross axes.

Machining scheme

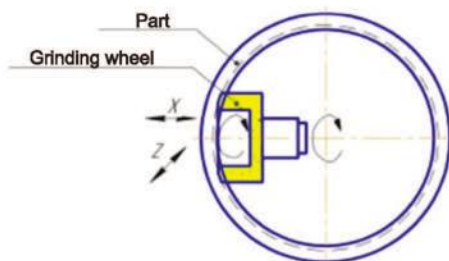

OSHP-259

NAME OF PARAMETERS	VALUE
Maximum dimensions of installed work piece, mm: - diameter of machined rings rolling track - outward diameter of machined rings - rings width	390...560 450...600 120...210
Grinding wheel drive power, kW	20
Controlled by CNC linear coordinates	X, Z
Discreteness of coordinates X, Z mkm	1
Overall dimensions: length x width x height, mm	3100 x 2200 x 1950
Mass, kg	5500

SPLINE GRINDING MACHINE WITH CNC MODEL OSH-628.1.F3

Spline grinding machine with CNC model OSH-628.1.F3 is designed for grinding straight and involute slots, as well as special profiles on parts such as "Slotted shaft", "Broach" by abrasive or CBN tool by method of mortise grinding. The design of the machine has a high rigidity, which ensures high-quality and productive processing of slotted surfaces. The machine uses high-quality components. The machine CNC system Sinumerik 840Dsl from Siemens has special software and mathematical support and a set of programs for processing slotted surfaces and profile slots.

The basic set of the machine includes:

- fencing of the working area of the open type;
- Renishaw touch sensor;
- driving headstock and tailstock with axis height adjustment (for processing conical spline surfaces);
- dressing mechanism with diamond roller;
- high-speed belt-driven grinding wheel spindle;
- cooling tank complete with pump and magnetic separator;
- Spare parts and attachments kit, including:
 - radius diamond roller R-2.5 mm;
 - mandrels for grinding wheels – 2 sets;
 - centers in the headstock and tailstock – 2 sets;
 - supporting 2 support lunette-1pc;
 - leashes for blanks – 1 set;
- adjustable supports for installing the machine on the foundation – 1 set.

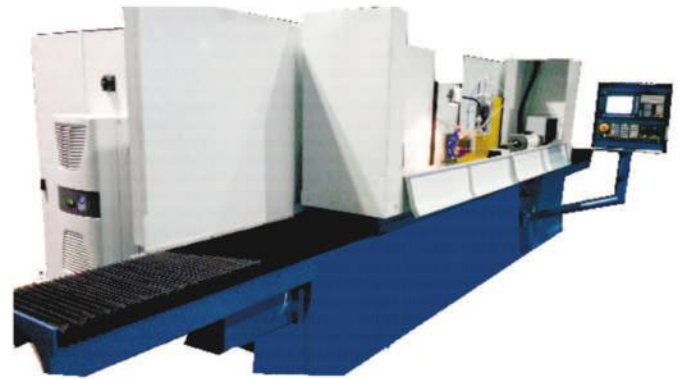

Optionally, the machine can be equipped with:

- cabinet fencing of the working area;
- aerosol suction unit;
- filter conveyor for the coolant tank;
- lunette, special leashes and supports for the customer's workpieces.

NAME OF PARAMETERS	Parameters value for versions		
	00	01	02
Maximum dimensions of the workpiece to be installed: - length x outer diameter, mm	600x180	1000x250	1600x250
Maximum mass of the workpiece to be installed, kg	40	80	80
Dimensions of the surface to be processed - length x diameter, mm - depth of the processed groove, mm	550x5...180 1...25	950x10...250 1...25	1550x10...250 1...25
Grinding wheel type 1 according to GOST R 52781-2007 - outer diameter, min...max, m - height, min...max, mm	63...150 6..20 (2x6...12)	63...150 6..20 (2x6...12)	63...150 6..20 (2x6...12)
Main drive power, kW	4,0	4,0	4,0
Cutting speed, m/s	20...50	25...50	25...50
Frequency of rotation of the grinding wheel, min ⁻¹	2500...18000	2500...18000	2500...18000
The frequency of rotation of the workpiece, min ⁻¹	0,01...30	0,01...30	0,01...30
Diamond roller of the grinding wheel dressing mechanism - outer diameter x profile radius, mm	125x2.5	125x2.5	125x2.5
Travel speed - longitudinal of table (coordinate X), mm/min - cross of wheel head (coordinate Z), mm/min - vertical of wheel head (Y coordinate), mm/min - rotation of the wheel head spindle (coordinate A), min ⁻¹	0,1...8000 0,01...4000 0,01...1600 0,01...30	0,1...8000 0,01...4000 0,01...1600 0,01...30	0,1...8000 0,01...4000 0,01...1600 0,01...30
Discreteness of moving by coordinates: - X,Y,Z, mm - A, degree	0,001 0,001	0,001 0,001	0,001 0,001
The maximum travel: - longitudinal of table (X coordinate), mm - cross of wheel head (Z coordinate), mm - vertical of wheel head (Y coordinate), mm - rotation of the headstock spindle (coordinate A), degree	800 160 350 Not limited	1200 160 450 Not limited	1200 160 450 Not limited
Overall dimensions of the machine with auxiliary equipment: - length, mm - width, mm - height, mm	2500 1900 1900	3600 2200 2150	4600 2200 2150
Weight of the machine with auxiliary equipment, kg	3600	5100	6700

SPECIAL SEMIAUTOMATIC SPLINE GEAR-GRINDING MACHINE WITH CNC MODEL OSH-628F3

Semiautomatic spline gear - grinding machine is designed for grinding of splines of straight or involute profiles, slots of random form and spur pinions.

NAME OF PARAMETERS	VALUE		
	OSH-628F3	OSH-628F3*04	OSH-628.1F3
Maximum dimensions of installed work piece: length x diameter, mm	600 x 390	1000 x 390	1600 x 250
Grinding wheel dimensions, D x H x d, mm	100 x 10...16 x 20	60/80/100/200x 13/20/32x10...25	125...250 x6...20x20,32
Possible number of machined splines (grooves), pcs.	1..999	1..999	1..999
Table mirror working surface dimensions: length x width, mm	1450 x 320	1750 x 320	2000 x 200
Distance between table mirror and centers axis, mm	200	200	130
Main drive power, kW	17,0	17,0	5,5
Grinding spindle rotation frequency, min-1	5000...24000	5000...12000	2000...10000
Maximum distance between table mirror and spindle axis, mm	600	600	400
Discreteness of travel over all coordinates axes, mm	0,001	0,001	0,001
Discreteness of headstock spindle turn, degree	0,001	0,001	0,001
Overall dimensions: - length x width x height, mm	4200x2770x 2460	4200x2770x 2460	6000x3200x 2050
Mass, kg	10250	10300	7600

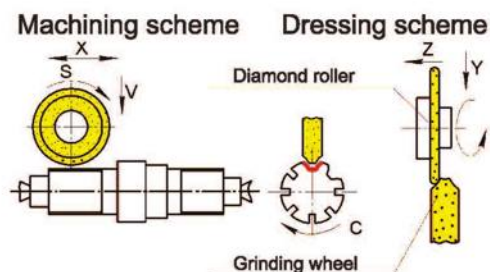

SPHERICAL GRINDING MACHINE WITH CNC

SPECIAL SEMIAUTOMATIC SPHERICAL GRINDING MACHINE WITH CNC MODEL OSH-643F3, OSH-656F3

Semiautomatic machine is designed for grinding of spherical surfaces of plugs of ball cocks made from stainless heat-resistant steels also with metal-ceramic coating and hardness 50...60 HRC by means of grinding wheel periphery. Sphere of use of machine is single and small-lot production, repair and restoration of ball cock plugs.

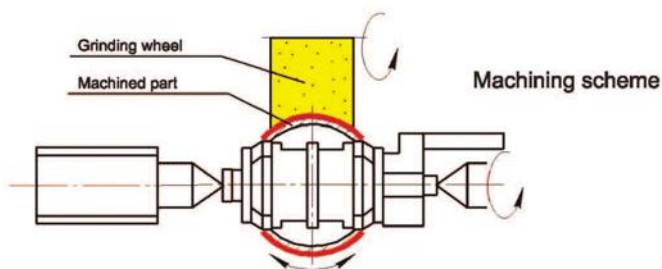

NAME OF PARAMETERS	VALUE	
	OSH-656F3	OSH-643F3
Limited dimensions of the machined work piece, - outward diameter, mm	20...200	80...900
Machining parameters: -roughness of machined surface, not less than Ra, mkm -accuracy of machining, mm	0,32 ± 0,002 on 100 mm mm of sphere diameter	0,32 ± 0,002 on 100 mm mm of sphere diameter
Grinding wheel dimensions (D x H x d), mm	500 x 20...65 x 127	500 x 60...100 x 203
Main drive power, kW	7,5...11	20,0
Overall dimensions: length x width x height, mm	4680 x 5050 x 2900	4500 x 3800 x 2900
Mass, kg	9000	10000

MACHINES FOR CREEP FEED GRINDING OF HARD-TO-MACHINE MATERIALS WITH CNC

MACHINE FOR CREEP FEED SINGLE-PASS GRINDING WITH CNC MODELS OSH-465, OSH-466

The OSH-465 and OSH-466 machines are quite simple in design and easy to use. They provide efficient processing of pre-milled grooves and spikes in parts made of various structural materials using the single-pass creep feed grinding method. Solid material processing is possible. The volume of the removed allowance is 100 ... 200 mm/s.

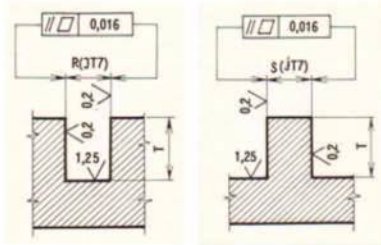

NAME OF PARAMETERS	OSH-465	OSH-466
Maximum dimensions of the workpiece to be installed (LxBxH), mm	840x290x400	840x395x500
Maximum dimensions of processed surface (LxB), mm	620x290	630x395
Maximum dimensions of grinding groove or pin (TxR) or (TxS), mm	40x40	40x40
Dimensions of the working surface of the table (LxB), mm	630x200	630x320
Stroke value, mm	790	790
Working/setting speed range, mm/min	30 ... 1000 600 ... 6000	30 ... 1000 600 ... 6000
Stroke value, mm	250	350
Feed	manual	manual
Distance from the axis to the table surface, mm	125 ... 550	140 ... 650
Speed range of adjustment travels, mm/min	15 ... 240	15 ... 240
The value of vertical feed (for wheel dressing), mm	0,02	0,02
Dimensions of the grinding wheel on request, mm	300x63x76	300x80x127 400x80x127
The rotation frequency of grinding spindle, rpm	1510	1510
Weight of the machine with auxiliary equipment, kg	3700	4200
Overall dimensions including moves and equipment (LxBxH), mm	4000x2050x2040	4000x2200x2200

2-SPINDLE SURFACE & PROFILE GRINDING MACHINE WITH CNC MODEL OSH-233

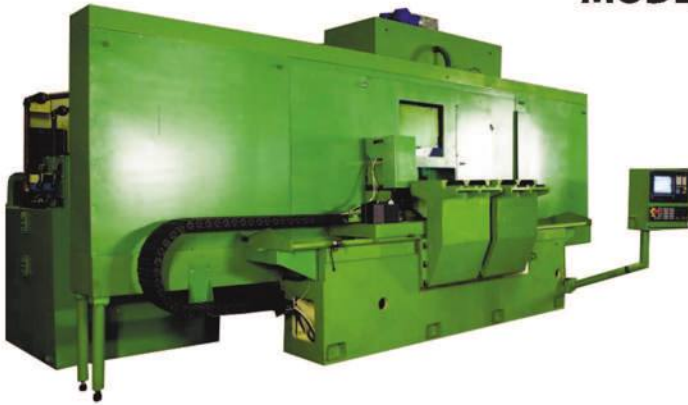

The machine is designed for two-sided processing by deep grinding of precision profile surfaces of the shank blades of gas turbine engines.

Parameters name	Value
Grinding limit dimensions, mm: - length width height	600 100 160
Dimensions of the working surface of the table (length x width), mm	1 800 x 400
Drive power of the main upper and lower motion, kW	2x28
Number of spindle rotations min ⁻¹	1 000 - 2 000
Grinding wheels, mm	500 x 10...100x203
Number of controlled coordinates and axes (X, Y1, Y2, Q1, Q2, W1, W2)	7
Control system	Sinumeric – 840DSL
Diameter of dressing roller	100...140 mm

CREEP FEED SURFACE PROFILE GRINDING MACHINE WITH CNC MODEL OSH-220, OSH-221F3

Machine is designed for abrasive machining by creep feed grinding the parts of machines from hard-to-machine materials including elements of motors blades and has an arrangement with traveling in longitudinal direction table and movable column traveling in cross direction bearing wheelhead with mechanism of continuous dressing by diamond roller.

Machine OSH-220 has six programmable coordinates.

Machine OSH-221F3 has eight programmable coordinates.

Machine OSH-221F3 vers. 04 has eight programmable coordinates with the possibility to install deep table.

Grinding of profile surfaces and also continuous dressing of grinding wheel are produced according to CNC controllable program in automatic mode with use of creep feed method of grinding.



NAME OF PARAMETERS	OSH-221	OSH-220	OSH-221F3 vers.04
Maximum dimensions of installed workpiece: - length x diameter x height, mm	800 x 400 x 500	800 x 400 x 480	200 x 400 x 500
Dimensions of grinding wheel: D x H x d, mm	500 x 10...100 x 203	500 (340) x 10...100 x 203	50 x 10...100 x 203
Maximum diameter of grinding spindle cone, mm	80	80	80
Main drive power, kW	28,0	28,0	28,0
Grinding spindle rotation frequency (infinite variation), min ⁻¹	800...2000	800...2000	800...6000
Overall dimensions: - length x width x height, mm	5000 x 5000 x 3230	4800 x 5000 x 3230	5100 x 3900 x 3230
Mass, kg	12000	12000	12000

SPECIAL MACHINE WITH CNC FOR CREEP PROFILE GRINDING MODEL OSH-680-F3

Machine has the arrangement with moving wheel head traveling in longitudinal, cross and vertical directions.

Machine is equipped with cooling system including pumps of coolant –lubricant feed into cutting zone, zone of grinding wheel dressing and to the device of parts washing and slime washout inside of enclosure, of coolant feed into wheel head body.

Machine is equipped with CNC system Sinumerik-840Dsl with Sinamics drives of the firm "Siemens" and feedback sensors of the firm "Fagor" over coordinates Z,Y,V.



OSH-680-F3

MACHINE PARAMETERS NAME	PARAMETER VALUE
Maximum dimensions of installed work piece: length x width x height, mm	800 x 500 x 500
Grinding wheel dimensions D x H x d, mm	250/500 x 10...110 x 127/203
Main drive power, not less than, kW	28,0
Maximum diameter of grinding spindle cone, mm	80
Grinding wheel spindle rotation frequency, min ⁻¹	800...8000
Overall dimensions of machine: length x width x height, mm	6000x4300x3100
Mass, kg	16000

MACHINES FOR GRINDING OF MOTOR CAMSHAFTS CAMS WITH CNC

SEMI-AUTOMATIC SPECIAL CIRCULAR GRINDING MACHINE WITH CNC FOR GRINDING OF CAMSHAFTS CAMS MODEL OSH-600 F3

Semiautomatic machine is designed for rough and finish grinding of camshafts cams with convex profile and also for machining of parts of the similar type with fixing in centres or chuck and for grinding of outer cylindrical and conic surfaces of flat and stepped workpieces.

The forming of cam profile is realized by means of programming, and change of cam profile dimensions – by means of re-programming of CNC system.



Machining schemes

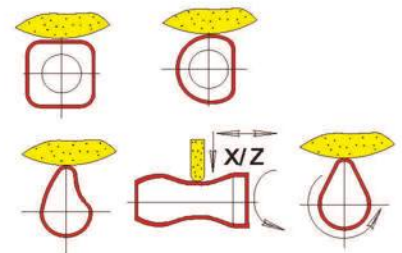

OSH-600F3

NAME OF PARAMETERS	OSH-600F3	OSH-600F3.1
Maximum dimensions of machined surface: diameter x length, mm	10...300 x 870	10...330 x 1450
Maximum value of ground cam lift, mm	145	
Adjustment travels speed, m/min: -of grinding wheel head(longitudinal, cross) -mechanism of continuous dressing	5 0,8	
Main drive power, kW	15	
Dimensions of grinding wheel installed on machine : D x H x d, mm	500 x 203 x 25	500 203x30...80
Overall dimensions with attached equipment: Length x width x height, mm	4440 x 3800 x 2460	5550 x 4300 x 1820
Mass, kg	6400	7200

MACHINES FOR INTERNAL GRINDING WITH CNC

SEMI-AUTOMATIC INTERNAL-FACE GRINDING MACHINE WITH CNC WITH TWO FIXED SPINDLES AND A MOVABLE WORK HEAD MODEL OSH-586.1.F3

NAME OF PARAMETERS	VALUE	
	OSH-586.1F3*02	OSH-586.1F3*03
Maximum dimensions of the workpiece to be installed: - length, max; mm - outer diameter, max, mm	250 300	220 110
Dimensions of the surfaces to be processed: - inner diameter; mm - outer diameter; mm - length; mm	12...150 150 140	3...25 80 70
Dimensions of the grinding wheels to be installed: No. 1 internal grinding spindle - outer diameter; mm - height, mm No. 2 face grinding spindle - outer diameter; mm - height, mm	20...63 20...50 250 20	25...20 10...20 250 20
Spindle №1 / №2 power, kW	7,5 / 1,5	2 / 1,5
Spindle №1 rotation frequency, rpm	5000...24000	9000...10500
Spindle №2 rotation frequency, rpm	2300	2300
Processed part rotation frequency, rpm	50...800	50...800
Speed of adjustment movements: - cross; m/min - longitudinal, m/min	7 7	7 7
Maximum travels: - cross; mm - longitudinal, mm	450 220	450 220
Angle of the work head rotation, degree	-10...+60	-10...+60
Discreteness of moving along the X and Z coordinates (resolution), mkm	1	1
Overall dimensions of the machine with auxiliary equipment: - length, mm - width, mm - height, mm	3150 2300 2600	2800 2900 1820
Weight of the machine with auxiliary equipment, kg	4000	3600

The semi-automatic machine is designed for grinding cylindrical and conical through and blind holes and adjacent external ends in parts of the "bushing" and "body" type.

The machine has an arrangement with the work head moving in the longitudinal and transverse directions relative to the fixed position on the bed of the internal grinding headstock and the end grinding spindle.

The workpiece is installed in the work head in a three-cam chuck. For processing conical holes, the work head is mounted on a swivel bracket that can be rotated at an angle of +60°... - 10°.

The machine is controlled by the Siemens Sinumerik-828D CNC system. The machine has 5 controlled coordinates and axes. The machine is equipped with a 24,000 rpm electric spindle and a touch sensor.



MACHINES FOR SIMULTANEOUS GRINDING OF FLAT PARTS FACES WITH CNC

SPECIAL SURFACE GRINDING AUTOMATIC MACHINE WITH CNC MODEL OSH-622F3

Automatic machine is designed for double-sided grinding of surfaces of parts made from steel, hard alloy and ceramics.

Machining of two surfaces of parts situated in cassette cells simultaneously is realized with feed on cutting-in of upper grinding wheel head with oscillating cassette travel.



OSH-622.3F3

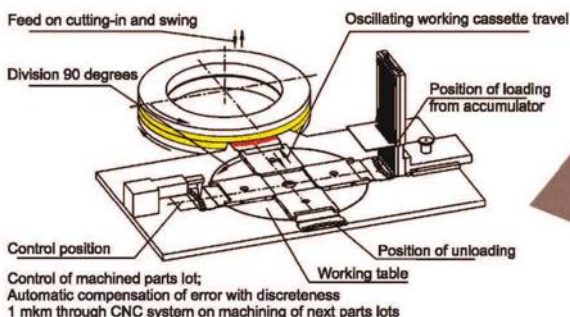

NAME OF PARAMETERS	OSH-622.3F3*01	OSH-622F3
Dimensions of el' bor borazon material or diamond grinding wheels : (D x H x d), mm	500 x 5 x 30	450 x 45 x 120
Dimensions of dressing abrasive wheel and diamond roller: (D x H x d), mm	-	125 x 16 x 32
Working feeds limits, mm/min: - of upper spindle - of dressing roller	1...200 1...200	1...200 1...200
Wheel heads spindles drive power, kW	22	7,5; 11,0; 15,0
Overall dimensions: length x width x height, mm	2000 x 5000 x 2500	2000 x 3100 x 2500
Mass, kg	7000	6000

MACHINES FOR PROFILING OF ABRASIVE GRINDING WHEELS WITH CNC

MACHINE FOR ABRASIVE GRINDING WHEELS PROFILING WITH CNC MODEL OSH-614

Machine is designed for performing of periphery profiling (shaping of geometrical profile) of abrasive grinding wheels.

Machine has the arrangement with dressing mechanism traveling in longitudinal and cross directions relative to motionlessly rotating grinding wheel. Dressing is produced by a special rotating diamond roller which has the opportunity of turn to the left and right sides relative to the top of radius ($R=0.2$ mm) of diamond roller.



NAME OF PARAMETERS	VALUE
Dimensions of dressing diamond roller, mm - maximum outward diameter; - inward diameter; - radius at the top;	150 32h5 0,2
Dimensions of grinding wheels installed on the machine, mm - maximum outward diameter; - minimum outward diameter; - inward diameter; - height;	320 231 76 10...130
Indications of main and auxiliary motions Quantity of controllable coordinates	5
Travels: - maximum longitudinal one (coordinate Z), mm - maximum cross one (coordinate X), mm - angle of diamond roller turn (coordinate B), degree	330 130 (-90/+45)
Overall dimensions of machine LxBxH, mm	2500 x 1700 x 2300
Mass, kg	1500

MACHINES OF DIAMOND – ELECTROCHEMICAL GRINDING WITH CNC

SEMI-AUTOMATIC MACHINE WITH CNC FOR DIAMOND-ELECTROCHEMICAL GRINDING OF SLOTS MODEL OSH-625EF3

Semi-automatic machine is designed for electrochemical grinding by diamond wheel of flat-profile surfaces and gap slots on parts made from hard machined materials: hard alloys, high-temperature alloys and steels on chromium-nickel basis, titanium alloys, etc.

Machining of surfaces over the whole with all the allowance removal is realized on the semiautomatic machine. Use of technological current source allows to realize the process of electric chemical grinding which includes anodic erosion of metal and diamond grinding. Machining is fulfilled by diamond conducting wheel with use of electrolyte and feed of potential "+" and "-" onto the machined part and wheel.

Machining of inclined and curvilinear surfaces and slots is possible.



OSH – 625EF3

Semi-automatic machine construction specific features:

- Cutting zone protection of cabinet type.
- Clearing of electrolyte from suspended particles of machining by means of centrifuge
- Travel of work members on rolling supports by means of rolling ball screw pairs.
- Linear and circular interpolation over coordinates X, Y and Z.
- CNC system SINUMERIK 828 D.
- Converters of linear travel – FAGOR.
- Drives – SINAMICS.
- Bearings of wheel head – FAG, IBC.

NAME OF PARAMETERS	OSH-625.1.EF3	OSH-625EF3
Table working surface dimensions : length x width , mm	630 x 200	450 x 200
Maximum table travel, mm	650	550
Maximum distance between table mirror and spindle axis, mm	415	415
Maximum working feed speeds, mm/min	0,01...250	1...250
Positioning accuracy over coordinates: Y, Z, mm	0,004	0,003
Main drive power, kW	2,2	2,2
Overall dimensions: length x width x height, mm	2500 x 1500 x 1900	2400 x 1500 x 1900
Mass, kg	2000	2000

KNEE-TYPE MILLING MACHINES

HORIZONTAL MODEL ORSHA-F32G, MULTI-PURPOSE MODEL ORSHA-F32U, WIDE MULTI-PURPOSE MODEL ORSHA-F32SH

Machines are designed for milling of the flat and contour surfaces by all kinds of mills.

Machines have a horizontal milling spindle with cone ISO-50.

Removable, rotary in the plane perpendicular to horizontal spindle axis, vertical milling head with spindle ISO-50 put in motion from horizontal spindle is used on multi-purpose machine.

Rotary in two planes vertical milling head with spindle ISO-40 is used on wide multi-purpose machine. The head is installed on the slider and has an autonomous drive.



ORSHA-F32G



ORSHA-F32U

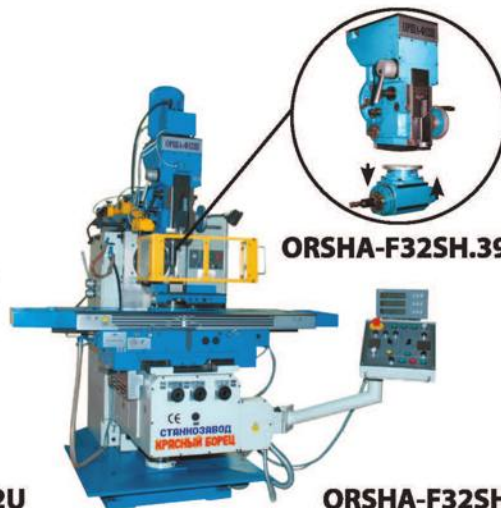

ORSHA-F32SH

Design advantages:

- Presence of frequency control of rate of induction electric motors of the main drive and feeds drive.
- Possibility to connect the hydraulic attachment of manufactured article clamping.
- Travels over axes X, Y, Z have mechanized and manual drive and are realized along the hardened cast-iron guide ways of sliding.
- Possibility of installation of the digital read-out device over coordinates X, Y, Z; FAGOR.
- Machine has master controller "Siemens", which controls the electrics and automatics of the machine and provides the operation in semiautomatic cycle.
- Presence of the recoil-approach mechanism over coordinate Z and mechanisms of discrete feeds over X, Y, Z coordinates.
- Presence of highly reliable hydraulic mechanism of tool clamping.
- Components of electric equipment of the best world manufacturers: SIEMENS.

NAME OF PARAMETERS	MACHINES MODELS		
	ORSHA-F32G	ORSHA-F32U	ORSHA-F32SH
Machines accuracy class	Heightened precision		
Dimensions of table working surface, mm (length/width)	1400/320		
Table maximum travel, mm:	840(1040)*		
- longitudinal (coordinate X)	320/-	320/265	320/320
- cross (coordinate Y) when operating with horizontal / vertical spindle			
Table working feed range, mm/min:	25...1250		
- longitudinal and cross (coordinates X and Y)	6...320		
- vertical (coordinate Z)			
Spindles rotation speed ranges, min ⁻¹ :	25...2000/-	25...2000/25...2000	25...2000/71...2240
- horizontal / vertical			
Milling spindles drive power, kW	7,5 / -	7,5 / 7,5	7,5 / 4,0
- horizontal / vertical			
Angle of turning of milling head, degrees	-	± 45	± 45 (in two planes)
Overall dimensions, mm: length x width x height	2427 x 1890 x 1745	2427 x 1890 x 2060	2454 x 1890 x 2425
Mass, kg	2938	3234	3500
DELIVERY SET			
Machine assembled	+	+	+
Hydraulic unit for lubrication	+	+	+
Cooling system	+	+	+
Hydraulic mechanical attachment of tools gripping	+	+	+
Guarding screens of cutting zone	+	+	+
Set of quick-wearing parts, tools and attachments	+	+	+
Digital read-out device over coordinates X, Y, Z	*	*	*
Bench vice	*	*	*
Universal indexing head	*	*	*
Set of boring arbors	*	*	*
Set of arbors and collet chucks for tools gripping	*	*	*
Rotary table with manual and mechanized drive	*	*	*

+ - Included into the delivery set * - at extra price

MILLING SEMIAUTOMATIC MACHINES WITH CNC:

VERTICAL KNEE-TYPE MILLING MACHINE ORSHA-F32VF3

HORIZONTAL KNEE-TYPE MILLING MACHINE ORSHA-F32GF3

Semiautomatic machines with CNC with table dimensions 320 x 1400 mm are designed for machining of the flat and profile surfaces of parts.



ORSHA-F32GF3



ORSHA-F32VF3

Design advantages:

- The use of ball-screw pairs of rolling motion in the feed units ensures smooth, high precision, backlash-free positioning.
- Drives of coordinate travels are realized from individual, controllable from CNC electric motors.
- Control of travels over three coordinates (X, Y, Z).
- CNC system SINUMERIK 828 DSL (SIEMENS), electric drives SINAMICS (SIEMENS).
- Rotary control panel.

NAME OF PARAMETERS	MACHINES MODELS	
	ORSHA-F32GF3	ORSHA-F32VF3
Dimensions of table working surface, mm - length - width	1400 320	
Discreteness of setting of travels over coordinates X, Y and Z, mm	0,01	
Table maximum travel , mm: - longitudinal (coordinate X) - cross (coordinate Y) - vertical (coordinate Z)	800 300 320	
Limits of spindle rotation frequencies, min ⁻¹	25...2000	800...4600
Limits of table working feeds in the following directions, mm/min: - longitudinal and cross (coordinates X and Y) - vertical (coordinate Z)	10...5000 8...800	
Speed of table rapid travels in the following directions, mm/min, not less than: - in longitudinal direction (coordinate X) - in cross direction (coordinate Y) - in vertical direction (coordinate Z)	8000 2000 1200	
Milling spindle drive power, kW	7,5	4,0
Maximum torque on spindle kN/m	1,0	0,17
Machine overall dimensions, mm: - length - width - height	3000 2230 1750	3000 2230 2450
Mass, kg	3200	3400

OPEN-SIDE CRANK PRESSES: INCLINABLE AND NON-INCLINABLE

Presses are designed for cold stamping operations in press forging and can function separately as well as a part of flexible technological system.



**ORSHA-800 (force 80 t)
Inclinable**



**ORSHA-1400 (force 140 t)
non-inclinable**

Design advantages:

- casted pig iron bed;
- hardened steel attachment guide ways of bed;
- use of brass straps on slider guide ways;
- frontal eccentric shaft disposition;
- mechanized slider disposition adjustment;
- centralized lubricating system;
- presence of safety washer or hydraulic safety device against overload;
- electric equipment components of "Siemens" production;
- presses mod. Orsha-800 are produced in two versions: inclinable and non-inclinable.

NAME OF PARAMETERS	PRESS MODEL		
	ORSHA-800 inclinable	ORSHA-800 – 40 non-inclinable	ORSHA-1400 non-inclinable
Nominal force kN(tf)	800 (80)	800 (80)	1400 (140)
Frequency of slider strokes, min ⁻¹ :			
- continuous		120	80
- single		45	30/38/45
Adjustable slider stroke, mm		10... 130	2... 150
Table dimensions, mm:			
- from right-to-left		800	1000
- from front-to-back		560	650
Maximum distance between table and slider in its lower position and with maximum stroke, mm		405	480
Adjustment value of distance between table and slider, mm		80	100
Slider dimensions, mm:			
- from right-to-left		560	650
- from front-to-back		400	425
Incline angle of bed, degrees	0; 10; 20	0	0
Main drive power, kW		8,5	15,0/18,5/22,0
Overall dimensions, mm:			
- from right-to-left	1820	1820	1930
- from front-to-back	2070	1730	1885
- height	3170	3085	3405
Mass, kg	7600	7000	11000

BENDING MACHINE

HYDRAULIC BENDING MACHINE MODEL MG-120

Multi-purpose bending machine is intended for bending of pipes, square profiles, strips, bars, angles, cutting-off of strips, rods, pipes, broaches, twisting, dies, blanks made of different materials with force up to 120 kN (12 t) in metal working. Most effectively the machine can be used under single-unit and small-scale production.

NAME OF PARAMETERS	VALUE
Table working surface dimensions, mm	
- length	600
- width	490
Maximum travel of base plate of power-driven hydraulic cylinder, mm, not less than	170
Maximum travel speed of base plate of power-driven hydraulic cylinder, m/min	
- forward	0,6
- backward	1,0
Maximum force of power-driven hydraulic cylinder, kN(t)	120 (12)
Distance from upper surface of the table to the floor, mm	950
Power of hydraulic pump drive electric motor, kW	2,2
Bending machine overall dimensions (without attachments), mm	
- length	1000
- width	760
- height	1120
Machine mass w/o attachments, kg	530



MG-120

Standard delivery set:

Bending machine

MG-120

Workpiece basing device

MG-120.55.0.000.0.00 - 1 pc.

Tools and accessories set

MG-120.90.1.000.0.00 - 1 set

Set of delivery at extra price:

NO. OF ADJUSTMENT	PURPOSE	DIMENSIONS OF BLANK, MM
MG-120.40.1	Attachment for strip bending	Height up to 130, thickness up to 6
42.2	Attachment for pipes and rolled stock bending	See adjustments for pipes bending
43.2	Attachment for chopping	Strip up to 8, circle up to 16, angle up to 32 x 4
47.1	Attachment for straightening	Circle, square, hexahedron up to 30, deflection (flexure) up to 15
50.1	Device for twisting	See adjustments 51.1 and 52.1
51.1	Attachment for strip bending along set profile	Length up to 400, width up to 50, thickness up to 3
52.1	Attachment for twisting axis	Length up to 520, width up to 30, thickness up to 2
64.0-00	Attachment for pipes bending	dy x S=15x2,8
64.0-01		dy x S=20x2,8
64.0-02		dy x S=25x3,2
64.0-03		dy x S=32x3,2
64.0-04		dy x S=40x3,5
64.0-05		dy x S=8x2,2
64.0-06		dy x S=10x2,2
65H2	Attachment for profile rolled stock	Circle, square, hexahedron up to 30
65H1	Attachment for strip bending	Width up to 60, thickness up to 6
49.0	Die for angle punching	Width of shelf up to 32, thickness up to 4

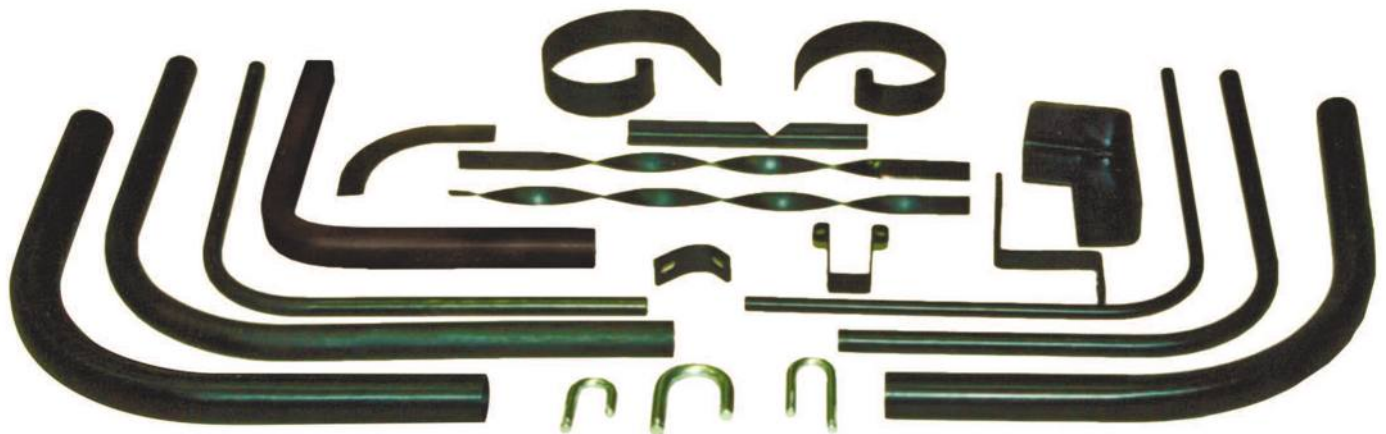

SMALL-SCALE MACHANIZATION

SHARPENERS

Sharpeners are designed for fitting works (deburring, chamfering etc.). Use of corresponding fixtures allows to carry out grinding and polishing of parts.



NAME OF PARAMETERS	MACHINES MODELS				
	TSH-1	TSH-2	TSH-3	TSH-4	TSH-4, vers. 01
Parameters of cutting tool on ceramic bundle (as per GOST P52781-2007), mm					
- outside diameter	250	300	400	400	600
- diameter of circle fitting hole	32	76	127	203	203
- circle height	40	40	50	50	50
Grinding wheels rotation frequency, min ⁻¹	1430		1410	1440	1000
Drive power, kW	2,2		3,0	7,5	7,5
Overall dimensions (LxBxH), mm	497x425x537	494x440x1263	559x580x1300	900x620x1340	900x815x1505
Power supply specification	a.c., three-phase , 50 Hz, 380 V				920
Mass, kg	55	80	152	380	440

The sharpeners have limit switches on housings for limitation of guard boards turning angle and socket for connecting vacuum cleaner 370.P16.

Sharpeners mod. TSH-1, TSH-2 and TSH-3 are manufactured on welded bed

ABRASIVE BELT GRINDING MACHINE OLSH-1

Machine is designed for stationary grinding of metal materials with use of abrasive belts. Machine is equipped with built-in vacuum-cleaner for dust collection.

NAME OF PARAMETERS	VALUE
Number of rotations of idling, min ⁻¹	1430/2790
Consumed power, W	3,0/3,75
Voltage, V	3x380
Frequency, Hz	50
Speed of abrasive belt, m/s	15/29
Number of rotations of fan, rpm	3000
Consumed power, W	0,37
Air consumption, m ³ /h	800
Suction vacuum, Pa	400
Overall dimensions, mm (length x width x height)	1130x583x1022
Mass, kg	125



GRINDING – POLISHING MACHINES MODEL TSHP-1, TSHP-2, TSHP-2, VERS. 01

The machines are designed for carrying out the following operations: deburring, chamfering, sharpening cutting tools, polishing the parts from steel, wood and other materials.

Machine consists of polishing device, working table of which has the possibility to incline in vertical plane on angle 45°. Simple and quick change of tape by means of one – lever clamp. Grinding or polishing wheel for grinding or polishing works is installed on the second end of the motor.



TSHP-1



**TSHP-2,
TSHP-2, vers. 01**

NAME OF PARAMETERS	VALUE		
	TSHP-1	TSHP-2	TSHP-2, vers. 01
Grinding wheel 25A F46 K6V 35m/s 2 class	1		
Outside diameter of wheel, mm	250	300	300
Wheel height, mm	40		40
Bore diameter, mm	32	76	76
Abrasive tape AB-150x1250 15A25Π	1		
Tape width, mm	50		
Shaft rotation frequency, min ⁻¹	1430		
Coarse-haired wheel A300x40 PCT PΦ 756-89 art. Φ0377	–	–	1
Tape length, mm	1250		
Maximum speed of wheel cutting, m/s	18,7	22,5	22,5
Maximum speed of tape motion, m/s	15		
Drive power, kW	2,2		
Power supply specification	a.c., three-phase , 50 Hz, 380 V		
Overall dimensions, mm (length x width x height)	610 x 450 x 680	610 x 450 x 1400	
Mass, kg	73,7	87	88,5

Parameters in brackets concern coarse-haired wheel.

CUTTING-OFF MACHINES

Machines are designed for cutting work pieces from metal and other materials off by cutoff wheel on bakelite basis with strengthening elements of other materials.

NAME OF PARAMETERS	MACHINES MODELS	
	OOS vers. 10	OOS vers. 01
Maximum dimensions of machined workpiece section (when the wheel is new), mm: channel, angle	80	
tube, solid circle (with re-installation)	Ø 50	
Angle of vice turning, degrees: clockwise / counter clockwise, degree	45/25	
Dimensions of cutoff wheel, mm	400 x 3,2 x 32	
Spindle rotation frequency, min ⁻¹	2100	
Drive power, kW	2,0	2,2
Overall dimensions : length x width x height (taking into consideration movable parts), mm	1280 x 1270 x 950	1280 x 1600 x 1500
Mass, kg	185	258
Power supply specification	a.c., three-phase , 50 Hz, 380 V	

ADVANTAGES:

1. Marking-out rod with re-adjustable rest allows to cut parts of equal length.
2. Fixation and unfixturing of rotary vice is carried out by simple turn of handle.
3. Massive cast iron table provides the necessary rigidity.
4. There is a window on the spark collector for connection of vacuum-cleaner mod. 370.P16x07.
5. OOS*01 is manufactured on welded base.



OOS vers. 10



OOS vers. 01

BENCH-TYPE MACHINES: DRILLING - MILLING MACHINE MOD. SF-1, DRILLING MACHINE MOD. SF-1 VERS. 07

Machines are designed for performing drilling and drilling-milling operations. Use of guide ways type "dove tail" gives stability of work during milling. Machines have re-set stop of drilling depth which creates convenience in work. Table has fixation in all directions. Machines SF-1 are equipped with frequency converter of spindle rotation speed adjustment without steps. Machines are equipped with the pedestal at extra payment.



SF-1



SF-1 vers. 07

NAME OF PARAMETERS	MACHINES MODELS	
	SF-1	SF-1 vers. 07
Maximum drilling diameter, mm		23
Maximum drilling out diameter, mm		35
Maximum diameter of installed cutter, mm	76	-
Dimensions of table working surface, mm (length x width)	450 x 180	250 x 250
Maximum travel, mm:		
- longitudinal travel of table;	260	-
- cross travel of table;	150	-
- vertical travel of wheel- head	280	200
Inward spindle cone	Morze 3-AT6 GOST 25557-82	
Rotation frequency range, min ⁻¹	300...1500/300...3000 (without steps)	320, 520, 810, 1350, 2100
Distance between spindle face and table working surface, mm:		
- minimum;	90	323
- maximum;	370	423
Poppet sleeve stroke length, mm		100
Turn of head in horizontal plane, degrees		±30
Drive power, kW		1,5
Overall dimensions, mm (length x width x height)	825 x 710 x 1005	705 x 440 x 1005
Mass, kg	200	150

MANUAL HYDRAULIC PRESS MODEL PGR

- Rigid welded frame construction
- Pressurization via pump lever
- Return spring bringing the piston to its original position

Designed for all repair and installation work:

- Piercing of bearings, bushings and bolts
- Dressing of carriers, shafts, axles and profiles
- Pressing and crushing

- Reliability of welds
- Dressing tools
- Control of the strength of materials



PGR-10



PGR-16

NAME OF PARAMETERS	PGR-10 (desktop)	PGR-16
Pressing force, t	10	16
The maximum pressure, Mpa	30	30
Stroke of piston, mm	135	140
Stroke of leadscrew, mm	70	70
Overall dimensions, mm:		
- Length	470	830
- width	200	1170
- height	860	1920
Mass, kg	65	260

CLEANING SYSTEM

INDUSTRIAL VACUUM CLEANER 370.P16

Vacuum cleaner is designed for suction of dust from surface grinding machines, sharpeners, cutting-off and other machines.

NAME OF PARAMETERS	VALUE		
	00	04	07
Version	00	04	07
For machines	Surface grinding machines	Sharpeners	Cutting-off machines
Number of arms, pcs.	1	2	1
Arm length, mm	2500	1000	
Diameter of impeller, mm	350		
Electric motor shaft rotation frequency, min ⁻¹	2800		
Productivity without arms and branch pipe connecting, m ³ /h	800		
Electric motor power, kW	1,1		
Overall dimensions, mm	610x475x1150	655x475x1150	610x475x1150
Mass, kg	52	56	54



370.P16

EXHAUST DEVICE

The device is designed for extraction of coolant-lubricant mist with impurities of solid dust and fine metal chips.

PARAMETERS NAME	VALUE		
	UV-600	UV-1200	UV-3000
Productivity, m ³ /h	600	1200	3000
Maximum level of noise, dB	80	80	80
Input diameter, mm	100	150	200
Rotation frequency, rpm	2800	2800	2800
Mass, kg	20	40	60

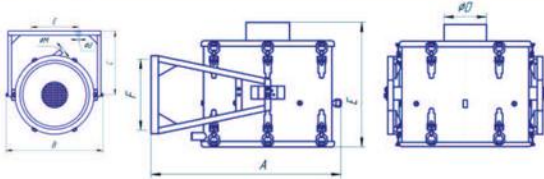

UV-1200.00.0.000.0.00

MAGNETIC SEPARATOR ORSHA-SM50

It is designed for automatic cleaning of coolant-lubricant from fine magnetic particles in mixture with abrasive and other non-magnetic particles.

NAME OF PARAMETERS	VALUE FOR VERSION		
	00; 05	10; 15	20; 25
Nominal consumption, l/min	50	100	150
Electric motor power, Kw	0,12		
Overall dimensions (LxBxH), mm	320 x 240 x 380	527 x 240 x 380	687 x 240 x 380
Mass, kg	28	36	52
Power supply specification	a.c., three-phase, 50 Hz, 380 V		



ORSHA-SM50

SWARF CONVEYOR MODEL OFC-4

Swarf conveyor is designed for collecting and removal of metal chip (swarf) from the processing zone of milling machining centre. Conveyor is equipped with the pump of lubricant - coolant feed into the part machining zone.

It is possible to make conveyor with other technical specifications as per customer's expression of requirements.



NAME OF PARAMETERS	VALUE
Width of supporting scrapers, mm	232
Pitch of drive chain, mm	63
Gear-motor drive with electric motor:	
- electric motor power, kW	0,25
- electric motor rotation frequency, min ⁻¹	1300
- output shaft rotation frequency, min ⁻¹	6,5
- reduction rate of gear –motor drive	201
Electric motor of lubricant-coolant feed pump:	
- electric motor power, kW	0,75
- electric motor rotation frequency, min ⁻¹	2790
- nominal feed, m ³ /h	3,2
Overall dimensions, mm	3240 x 1015 x 1580
Mass, kg	395

RECTANGULAR ELECTROMAGNETIC AND MAGNETIC CHUCKS WITH CROSS ARRANGEMENT OF POLES

Chucks are designed for fixing of the blanks from ferromagnetic materials being machined on surface grinding machines.

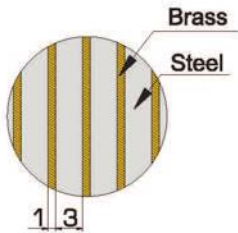

Distance between poles

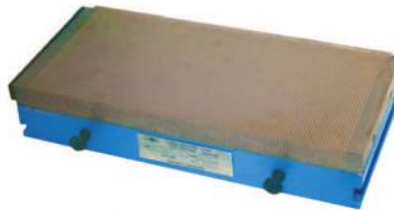

Electromagnetic chuck

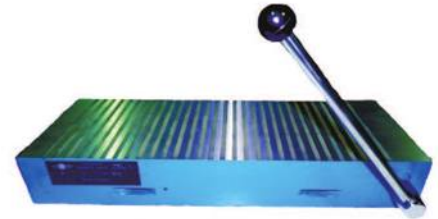

Magnetic chuck

Design features and advantages:

- Possibility of use for fixing parts of small dimensions which is ensured by small distance between poles and cross arrangement of poles;

- Complete hermetic sealing of chucks for ensuring their utilization using coolant;
- High rigidity and accuracy.

NAME OF PARAMETERS	ELECTROMAGNETIC CHUCK									
	7208-0059-05	7208-0060-05	7208-0063-05	7208-0066-05	7208-0067-05	EMP-4080-05	EMP-40110-05	EMP-6080-05	EMP-60120-05	EMP-73120
Chuck accuracy class as per GOST 30273-98	Heightened precision									
Chuck mirror dimensions (BxL), mm	200 x 450	200 x 630	320 x 630	320 x 1250	400 x 630	400 x 800	400 x 1100	600 x 800	600 x 1200	730 x 1200
Rated mains supply voltage, V	110 V direct current (D.C.)									
Chuck current (when direct current voltage is 110 V), A	0,52	0,7	0,98	0,98	1,4	1,6	2,4	3,21	3,21	3,81
Specific force of attraction with full loading of the working surface, N/cm ²	25									
Mass, kg	55	75	125	250	135	200	325	350	485	590

NAME OF PARAMETERS	MAGNETIC CHUCK		
	7208-0012	7208-0011	7208-0017
Chuck accuracy class as per GOST 16528-84	Heightened precision		
Chuck mirror dimensions (BxL), mm	200 x 560	200 x 630	320 x 630
Specific force of attraction, N/cm ²	80		
Mass, kg	41,5	39,5	81,5

MAGNETIC CHUCKS

Magnetic chuck is designed to secure the workpiece (mainly of ferromagnetic materials of flat products such as discs, rings, etc.) when they are processed on surface grinding machines. The technical characteristics comply with GOST 24568-81.

Parameters name	7108-0006
Outer diameter, mm	200
Height, mm	75
Specific gravity N_y on pole-not less N/cm ²	40
Chuck mass, kg	12,0



MULTI-PURPOSE INDEXING HEAD

It is designed for different milling, gear milling, boring, drilling, marking and other operations connected with turning of part on the desired magnitude. The delivery set contains chuck, tailstock center, support. Heads are manufactured in two versions: version 00 is without accessory gears; version 01 – with accessory gears (swing frame).



7036-0053

NAME OF PARAMETERS	VALUE				
	7036-0051	7036-0052	7036-0053	7036-0054	7036-0055
Maximum diameter of machined article, mm	160	200	250	320	400
Transmission ratio of worm indexing head transmission	1:40	1:40	1:40	1:40	1:40
Overall dimension (LxBxH), mm	340x415x185	380x435x240	380x460x250	428x500x305	428x500x350
Mass of head, kg not more	40	50	55	105	110
Total mass of head with attachments, kg not more					
- 00 version	70	90	90	140	160
- 01 version	85	101	106	155	175



3E70.P01

GRINDING WHEEL BALANCING ATTACHMENT 3E70.P01

3E70.P01 – Maximum diameter of balanced wheel – 320 mm
 3E70.P01-04 - Maximum diameter of balanced wheel – 400 mm

CIRCULAR INDEXING SINE TABLES 3E70.P11

Table diameter – 160 mm
 Maximum angle of table tilting – 45 °
 Variants of delivery – with magnetic, three cams chuck or without it.
 Overall dimensions (LxBxH) – 240x224x240 mm.
 Maximum mass of attachment – 32 kg.



3E70.P11



3E70.P13

CIRCULAR ROTARY SINE TABLES 3E70.P13

Table (chuck) diameter – 160 mm
 Maximum angle of table tilting – 45 °
 Rotation frequency of table or magnetic chuck – 41 rpm
 Variants of delivery – with magnetic, three cams chuck or without it.
 Maximum mass of attachment – 56 kg.

LONGITUDINAL SINE TABLES 3E70.P20

Dimensions of table surface (version without electromagnetic chuck) – 400 x 200 mm.
 Dimensions of table surface (version with electromagnetic chuck) – 450 x 200 mm.
 Maximum angle of table tilting – 45 °
 Variants of delivery – with electromagnetic chuck or without it.
 Maximum overall dimensions (LxBxH) – 450 x 200 x 184 mm.
 Mass of attachment without chuck – 35 kg, with chuck – 85 kg.



3E70.P20

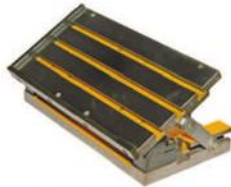

3E70.P21

CROSS SINE TABLES 3E70.P21

Dimensions of table surface (version without electromagnetic chuck) – 400 x 200 mm.
 Dimensions of table surface (version with electromagnetic chuck) – 450 x 200 mm.
 Maximum angle of table tilting – 45 °
 Variants of delivery – with electromagnetic chuck or without it.
 Maximum overall dimensions (LxBxH) – 450 x 200 x 184 mm.
 Mass of attachment without chuck – 35 kg, with chuck – 85 kg.

GRINDING WHEEL ANGULAR DRESSING ATTACHMENT 3E70.P32

Width of grinding wheel dressing – 75 mm.
 Maximum angle of dressing - 60 °
 Overall dimensions (length x width x height) - 205 x 220 x 120 mm
 Mass of attachment – 9,8 kg.



3E70.P32



3E70.P35

GRINDING WHEEL RADIUS DRESSING ATTACHMENT 3E70.P35

Maximum dressing radius (convex/concave) - 68/31 mm
 Overall dimensions (length x width x height) - 396 x 160 x 240 mm
 Mass of attachment - 16,5 kg

TEMPLER VICE 3E70.P40 / PRECISION VICE 3E70.P41

Thickness of workpiece gripped - 0,5 ...70 mm / 0,5 ...100 mm
 Width of vice jaw - 69 mm / 119 mm
 Overall dimensions (length x width x height) - 300 x 70 x 50 mm / 300 x 120 x 80 mm
 Mass of attachment - 3,3 kg / 13,3 kg



3E70.P40, P41



3E70.P42

SINE VICE 3E70.P42

Thickness of workpiece gripped – 0,5...90 mm
 Width of vice jaw – 119 mm
 Maximum swiveling angle of vice – 45 °
 Overall dimensions (length x width x height) – 390 x 160 x 144 mm
 Mass of attachment – 24,5 kg

GRINDING WHEEL DRESSING ATTACHMENTS

3D70.P43 (mechanical), 3D70.P46 (hydraulic),
 3D70.P47 (electric)

Maximum vertical stroke of poppet sleeve
 Without resetting / with resetting – 10/102 mm
 Maximum horizontal stroke of poppet sleeve – 90 mm



3D70.P43, P46, P47



3E70.P50

INDEXING DEVICE 3E70.P50

Number of slots in index disk – 24
 Maximum diameter of workpiece installed – 100 mm
 Maximum length of installed part – 340 mm
 Overall dimensions (length x width x height) – 630 x 225 x 140 mm
 Centres height – 116 mm. Mass – 35 kg

SWIVELING SINE SQUARE 3E70.P54

Maximum tilting angle of sine edge - ± 60 °
 Maximum swiveling angle of square - ± 60 °
 Overall dimensions (length x width x height) - 195 x 200 x 200 mm
 Mass - 9,5 kg



3E70.P54

LEVER SHEARS FOR CUTTING METAL MOD. NRL, NRL-1



NRL

Lever shears are designed for cutting blanks from sheet metal, bars from circle and other profiles.

The advantages of lever shears are as follows:

- easy, smooth cutting along all the length of cutting;
- high quality knife.

NAME OF PARAMETERS	VALUE	
	NRL	NRL-1
Knife length, mm	150	180
Maximum thickness of cut sheet, mm	4	8
Maximum diameter of cut bar, mm	11	15
Maximum dimension of cut square, mm	–	14
Maximum dimension of cut angle piece, mm	–	40



NRL-1

DRILLING BENCH VICE MODEL TSS-1

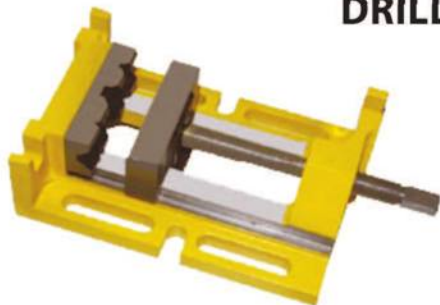

Vice is designed for parts fixation when doing metal working and drilling. Vice can be installed on the face and two side surfaces in addition to the main basic surface. Vice can be equipped with accessory prism jaws for fixation of cylinder parts.

NAME OF PARAMETERS	VALUE
Jaws width, mm	125
Jaws height, mm	50
Maximum stroke of mobile jaw, mm	125
Overall dimensions: length x width x height, mm	352 x 150 x 85
Mass, kg	12

METALWORK CRAMP MODEL SS-1



Cramp is designed for precise angle fixation of parts under right angle when doing welding or mounting works. It provides endurance of angle 90° for any connections independent on connections type: angle, joint, connection with bevel or T-type one. Swimming jaw allows to make butt-jointing and welding of parts of different thickness.

NAME OF PARAMETERS	VALUE
Maximum opening of gripping jaws, mm	100
Jaws height, mm	50
Overall dimensions: length x width x height, mm	470 x 326 x 85
Mass, kg	10

DIE FOR EDGE CUTTING-OUT OF PIPES MOD. SHKVT



Die for edge cutting-out of pipes is designed for machining pipes 27 – 43 mm from steel or non-ferrous metals and alloys with thickness of wall up to 3 mm, butt-jointing of pipes to each other or welding under angle 90°, combining of one construction from several pipes of different diameter, has horizontal and vertical operation, fits for double-sided connections. Mass is 7,6 kg.

UNIVERSAL BENDING ATTACHMENT MODEL PUG-1

Universal bending attachment allows to form curvilinear profiles from strip (band-pass), round and square rod material including angles, rings, spirals and hoops. The received configurations are the initial material designed for making window and garden grates, gates, wickets, other different tracery constructions from steel, brass, copper and aluminium. The most effective use is in single- and small – series enterprises and also at home.



NAME OF PARAMETERS	VALUE
Maximum diameter of round rod for bending, mm	10
Maximum width of square rod for bending, mm	10
Maximum dimensions of sheet strip for bending, mm	30 x 8
Overall dimensions L x B x H, mm	390 x 695 x 145
Attachment mass, kg	26

METALWORKER'S WORKBENCHES MODEL OVS

Metal metalworker's workbenches models OVS are designed for convenient organization of working place in work-shops, educational establishments, shops and garages.

Workbenches are purchased as a set which can include different variants of table tops and pedestals (boxes quantity and dimensions) as per order. In addition the workbenches can be equipped with holed (perforated) screens (square perforation) and lighting. Workbenches colour of painting and paintwork materials are coordinated with the customer. Delivered knocked-down (kd).

SINGLE-PEDESTAL WORKBENCH model OVS 01.103 (OVS 02.106 without lamp)

- pedestal with drawers (according to order from 2 to 6 drawers)
- central lock of all drawers shut-off
- telescoping guides of drawers
- drawers complete moving-out
- post with luminaire
- permissible loading on drawer: on a small one – 15 kg, on a large one – 30 kg
- holed (perforated) screen with square perforation , height of one section is 200 mm;
- table top (as per order):

Postforming (plastic) with thickness of 28 mm, overall dimensions 1390 x 700 mm (OVS 01.103);

Plywood with thickness of 30 mm with metal covering with thickness of 2 mm, overall dimensions 1390 x 700 mm (OVS 02.106 without lamp);

-overall dimensions of workbench: 1390 x 700 x 850 h mm

-weight 95 kg

-uniform load: 500 kg.



DOUBLE - PEDESTAL WORKBENCH model OVS 01.236

- pedestal with drawers (according to order from 2 to 6 drawers)
- central lock of all drawers shut-off
- drawers complete moving-out
- permissible loading on drawer: on a small one – 15 kg, on a large one – 30 kg
- table top (as per order):

Postforming (plastic) with thickness of 28 mm, overall dimensions 1900 x 700 mm;

Plywood with thickness of 30 mm with metal covering with thickness of 2 mm, overall dimensions 1900 x 700 mm;

-holed (perforated) screen with square perforation , height of one section is 200 mm;

-post with luminaire

-overall dimensions of workbench: 1900 x 700 x 850 h mm

-weight 120 kg

-uniform load: 500 kg.

TOOL TROLLEY TI-1

Tool trolley mod. TI-1 is designed for storage and efficient movement of tools and attachments at the industrial enterprises, in service centers and job shops.

Painting colour of tool trolley is coordinated with the customer. Delivered assembled.

The trolleys are equipped with convenient handles, upper tray with niches for storage of tools and hardware, rubber wheels (diameter 100 mm): 2 pcs. – rotary ones, 2 pcs. – rotary ones with brake.

- telescoping guides of drawers
- drawers complete moving-out
- central lock of all drawers shut-off
- number of drawers (as per order from 3 to 6 drawers)
- permissible loading on drawer: on a small one – 15 kg, on a large one – 30 kg
- side panels with perforation for possibility of fastening holders and hooks for tool storage
- maximum loading on trolley is 200 kg
- overall dimensions 825 x 465 x 840 h mm subject to the wheels
- weight 40 kg.



TROLLEY – BIN FOR CHIPS COLLECTION AND TRANSPORTATION

Tilting trolley-bin is designed for collection and transportation of the chips from metal working machines.

Overall dimensions: 817 x 1130 x 400 mm

Weight: 80 kg



METAL WARDROBE 18-7808-5529



Metal wardrobes are designed for storage of working clothes in workshops, service centers, job shops and private workrooms.

Overall dimensions: 800 x 1816 x 500 mm.

Weight: 113 kg.

MOVABLE RACK ARRANGEMENT (STILLAGE) SP-1

Overall dimensions: 1500 (1000) x 750 x 845 mm

Weight: 25 kg



DRAWING STORAGE RACK 18-7808-5566X01

The metal rack is designed for convenient storage of documents and drawings in a vertical position at production plants and workshops.

There are 6 horizontal shelves. The shelves are equipped with re-installable cells for convenient storage of documents in a vertical position.

You can connect multiple racks in a section.

Overall dimensions of the rack: 980x320x2004 mm.



MODERNIZATION AND MAJOR REPAIRS OF GRINDING MACHINES

One of directions of plant activities is a restoration, repair and modernization of grinding equipment of own production as well as of other producers. The plant actively works over searching customers, carries out technical expertise of equipment, offers the variants of modernization and repair to customers on different base of home-made as well as foreign components.

Plant realizes major repairs and modernization of the below listed and other grinding equipment:

LSH-220 – surface & profile grinding machine with CNC for creep feed grinding of profile surfaces and deep slops of parts from heatproof and other hard-to-cut materials. Producer: “Lipetsk machine-tool plant”, Russia.



LSH-233 – special twin-spindle surface & profile grinding machine with CNC for double-sided processing by method of creep feed grinding of precision surfaces of shank ends of gas turbine engine blades.

Producer: “Lipetsk machine-tool plant”, Russia.

SS-13 - special twin-spindle surface & profile grinding machine with CNC for double-sided processing by method of creep feed grinding of precision surfaces of shank ends of gas turbine engine blades.

Producer: «ELB-SCHLIFF WZM GmbH», Germany

CHURCHILL model SHC – spline grinding machine with CNC

Producer: «CHURCHILL», Great Britain

REFORM models RSM-1600, RSM-2500 – spline grinding machines with CNC

Producer: «REFORM Maschinenfabrik Adolf Rabenseifner GmbH Co. KG», Germany

WERNER model SKR-20a - spline grinding machine with CNC

Producer: «FRITZ WERNER werkzeugmaschinen GmbH», Germany



The list of operations on modernization and major repairs includes:

- restoration of accuracy parameters and polymer coating of guide ways;
- replacement of ball-screw pairs;
- replacement ball-bearings and seals;
- replacement of system of cooling and coolant-lubricant feed pumps;
- replacement of working zone protection;
- replacement of end switches;
- replacement of low voltage equipment;
- replacement of control system by CNC SINUMERIK 840D and electric drive into SIMODRIVE 611;
- replacement of hydraulic equipment;
- replacement of feedback transducers by converters HEIDENHAIN;
- replacement of all electric communications of machines;
- assembling and start-adjustment works;
- guarantee and post-guarantee servicing;
- personnel training

Modernization will allow:

- to widen technological capabilities of equipment;
 - to increase productivity;
 - to heighten accuracy of machining;
 - to reduce expenses on maintenance;
 - to increase the memory volume for programs processing;
 - to heighten possibility of machines network for transmitting controlling programs and data acquisition (DAQ) about equipment operation, quick diagnostics (troubleshooting).
- These indices heighten economic efficiency of production.

WORKS ON MACHINING PROCESS OF PARTS AS PER CUSTOMER'S DRAWINGS

OJSC Machine-tool plant "Krasny borets" fulfills the following works:

1.	Machining process:	
1.1.	Turning	- maximum diameter of machined part: above bed is 630 mm, above compound slide is 350 mm, maximum length of machining is 2800 mm;
1.2.	Milling	- maximum width of machined part is 1 800 mm; - maximum length of machined part is 6 000 mm;
1.3.	Horizontal boring	- table working surface dimensions -1600 x 1800 mm; - maximum vertical travel is 1500 mm; - maximum longitudinal travel is 2000 mm; - maximum cross travel is 1500 mm;
1.4.	Drilling	- maximum drilling diameter: steel 50 mm; cast iron 63 mm; - range of threading: steel 45 to M52 x 5, cast iron C4 20 to M64 x 4; - possibility of threading with non-standard pitch;
1.5.	Cylindrical grinding	- maximum diameter of machined part is 340 mm; - maximum distance between centres is 1400 mm;
1.6.	Internal grinding	- maximum diameter of installed part is 360 mm; - maximum length of grinding is 700 mm;
1.7.	Longitudinal grinding	-maximum dimensions of machined part: height 1250 mm; width 1450 mm, length 4000 mm, distance between posts 1540 mm;
1.8.	Profile grinding (cylindrical parts)	- maximum diameter of installed part is 390 mm; - maximum length of installed part is 500;
1.9.	Gear milling (cylindrical gears)	- maximum diameters of machined part is 350 mm; - maximum modulus is 6;
1.10.	Gear grinding (cylindrical gears)	- maximum diameters of machined part is 40-320 mm; - machined part modulus is 0,5-4 mm; - number of machined part teeth is 12-200;
2.	Galvanic processing:	
2.1.	Chemical oxidation	- maximum loading according to overall dimensions 1100x500x600 mm; - maximum weight is 200 kg;
2.2.	Chromizing	- stationary bath is 1200x150x600 mm;
2.3.	Glittering nickelizing	- stationary bath is 1200x150x600 mm;
2.4.	Galvanization (small ironware and hardware)	- part maximum weight is 0,1 kg; - maximum loading of drum is 20 kg;
3.	Iron casting (gray cast iron C420)	- maximum weight of casting in clay - sandy mold is 1,5 t;
4.	Heat treatment:	
4.1.	Hardening by RF current	Bodies of rotation and guide ways: - maximum length of installed part is 1400 mm; - maximum weight is 60 kg; Large-size parts: - maximum length of installed part is 2000 mm; - maximum height of installed part is 800 mm; - maximum width of installed part is 900 mm;
4.2.	Bulk hardening	- working space of furnace is 600x400x1000 mm;
5.	Laser processing:	
5.1.	Sheet metal laser cutting	- maximum thickness of machined sheet is 20 mm; - maximum overall dimensions of machined sheet are 1500x3000 mm;
5.2.	Laser marking (of round and flat parts)	- maximum diameter and weight of round part is 180 mm, kg; - maximum dimension of flat part is 250x250 mm;
6.	Gas-plasma processing:	
6.1.	Sheet metal plasma cutting	- maximum thickness of machined sheet is 30 mm; - maximum overall dimensions of machined sheet are 1500x3000 mm;
6.2.	Sheet metal gas cutting	- maximum thickness of machined sheet is 90 mm; - maximum overall dimensions of machined sheet are 1500x3000 mm;
7.	Bending:	
7.1.	Sheet metal bending	- maximum thickness of machined sheet is 5 mm; - maximum length of machined sheet is 3000 mm;
8.	Painting of sheet, basic and body parts, fabricated constructions.	

Plant has an opportunity to make different types of fabricated metals according to customer's design documentation (ECO).

DEALERS



TURKEY

«ADIL MAKINA SANAYI VE TICARET, ADIL UNAL»

Oto Sanayi Sitesi, Aytekin Sok. No 12
4. Levent – Istanbul – TURKEY
tel.: (90 212) 264 79 19 Fax: (90 212) 270 32 19
e-mail: adilmakina@superposta.com www.adilmakina.com



POLAND

«MEXIM Sp.z.o.o.»

ul. Grafitowa 10, Radwanice 55-010 Sw. Katarzyna
NIP: 896-13-95-883 POLAND tel.: (48 71) 311-73-38
e-mail: biuro@mexim.pl www.mexim.pl



GERMANY

Heinz Stöckel Werkzeugmaschinen GmbH

Gewerbegebiet auf der Weith, Herborner Str. 47,35745 Herborn,
Deutschland.
tel.: (1049)-2772/9400-0; fax: (1049)-2772/940050
e-mail: info@stoeckel.de; m.kaempfer@stoeckel.de www.stoeckel.com

MACHINE-TOOL AND TOOL ENTERPRISES OF THE REPUBLIC OF BELARUS



OJSC Machine-tool plant "Krasny borets"
<http://krasnyborets.com>



**OJSC "MZAL named after
P.M. Masherov"**
<http://mzal.by>



OJSC "StankoGomel"
<http://www.stankogomel.by>



OJSC "GZSU"
<http://www.gzsu.by>



OJSC "VISTAN"
<http://www.vistan.ru>



OJSC plant "VIZAS"
<http://www.vizas.org>



**OJSC "Machine-tool plant named
after S. M. Kirov"**
http://up_szk@mail.ru



OJSC "Orsha toolmaker"
<http://orshainstrument.ucoz.ru>



OJSC "BelTAPAZ"
<http://beltapaz.com>



OJSC "BZSP"
<http://bzsp.by>



OJSC "GLZ "CENTROLIT"
<http://www.centrolit.com>



OJSC "GSKTB GA"
<http://www.gsktb.com>



OJSC "MISOM OP"
<http://misom.by>



OJSC "Institute "BELORGSTANKINPROM"
<http://www.belstanki.by>



OJSC "UPNR"
<http://www.upnr.by>



211391, The Republic of Belarus
Vitebsk region, Orsha, Friedrich Engels str., 29

Director's reception-room:
tel. +375 216 51 81 22; fax: +375 216 51 81 23

Department of export and foreign economic relations:
tel. +375 216 51 81 57
Tel./Fax: +375 216 51 81 56

E-mail: borets@vitebsk.by
<https://en.krasnyborets.com>



STB ISO 14001-2005
STB ISO 9001-2009